

***MIDI Software for  
Atari ST & STE***



**FRACTAL**



**MUSIC**



***The Music Generator  
and Processor from***



***atamusic***



**FRACTAL MUSIC** is also a powerful music processor, including as it does extensive and unusual editing features (using, among other things, transformation geometry), as well as a couple of more common ones. These facilities can be used to edit not only the material you have created from within **FRACTAL MUSIC**, but any material you have produced using a sequencer, via MIDI File.

This manual should help you in understanding how to use **FRACTAL MUSIC**, and will go some way towards explaining some of the more *recherché* aspects of the program (without giving away too many secrets, of course).









We will begin by getting you started, then taking you through a quick tutorial. This will by no means show you everything **FRACTAL MUSIC** can do (it will use only two of the **Edit** functions, for example), but should act as a taster to get you going, and convince you that it's all *VERY EASY* to do. After that, each part of the program is looked at in detail, to open up all the possibilities to you. There is a series of Appendices at the back, with reference tables and some more detailed technical information for those that care about that sort of thing.







We hope that **FRACTAL MUSIC** will introduce you to a new world of musical possibilities—who knows, it might even turn you into a highly significant composer (if you already are, please accept our apologies).

- This software has been tested on various configurations of Atari ST and STE computers, with memory from ½ to 4 megabytes, in monochrome (high resolution) and colour (medium resolution), and no problems have arisen. No conflicts have been found between **FRACTAL MUSIC** and a number of software system enhancements including *Neodesk 3* and *Quick ST/STE*.

## TYPOGRAPHICAL CONVENTIONS

Throughout this manual, the following conventions will be adhered to:

- All keypresses required will be shown as “keycaps” like this: . (See p.6)
- Modifier keys are shown as ,  for Control and  for Alternate.  denotes the Backspace key and  the Delete key.
- Some examples: , , .

- ⇒ The word *num* after a key's name indicates the numeric keypad. Where necessary, *main* will specify the main keyboard.
- ⇒ Some examples: num, num, main.
- ⇒ Whenever  is mentioned,  can also be used.
- ⇒ Any “OK” or “EXIT” buttons are default buttons, so  or  can always be pressed as an alternative.
- ⇒ Mouse clicks will be given as:
  - L-click** Click left button
  - L-hold** Hold left button down
  - R-click** Click right button
  - R-hold** Hold right button down
  - B-click** Click both buttons
  - Click** Click either button in the program's own functions, or the left button in system functions (alert/dialog boxes, menus, file selector, etc.). You'll soon get used to which is which, but if in doubt just use the left button (no political significance intended).
- ⇒ Mouse and keyboard commands are shown side by side under the headings **MOUSE** and **KEYBOARD** where alternatives are available.

## TIME DISPLAY

At various points in the program (and in some illustrations in the manual), you will see the position in time of a MIDI event displayed. This might look like: 0142.68. This means beat 142, tick 68. There are 96 ticks to a beat, so the two figures after the dot are never higher than 95—this is not a decimal value. The total time span available in **FRACTAL MUSIC** runs from 0000.00 to 9999.95. How long this actually lasts depends, naturally, on the tempo. This is most directly relevant to **Stretch/Move** and **Event List**—see the sections on those features.

If any of the above is unclear to you, you should find adequate explanations in **For ST Novices (Chapter 2.1)** or the **Glossary (Appendix F)**.

## THE AUTHORS



**FRACTAL MUSIC** and this manual were written by Chris Sansom, with invaluable advice and assistance from Laurence Glazier.

- ⇒ **Chris Sansom**, B.Mus. is a London-based composer who has worked in a wide range of musical fields, leading to a number of public performances and broadcasts on BBC Radio 3. Numerical methods have been an important element of his compositional technique since his student days, and programming has been a natural part of that evolution. **FRACTAL MUSIC** began as a tool (complete with genuine user-hostile interface) for use in his own compositions ... and grew.
- ⇒ **Laurence Glazier**, M.A., founder of *o<sub>l</sub>atamusic*, is an experienced computer programmer with an abiding interest in music and all things mathematical—and the relationship between the two. His constructive criticism, ranging from overall appraisal of user-interface to detailed examination of code and from high praise to minute nit-picking, was an essential part of the early development of **FRACTAL MUSIC**.
- ⇒ Our thanks to **Philippa Vides** who performed an invaluable service in proof-reading and testing this manual; and to others too numerous to list for their constructive suggestions, some of which have been implemented and/or included in the manual, since **FRACTAL MUSIC** first appeared.

### THIS MANUAL

The very first **Fractal Music** manual was produced using *First Word Plus* and *Timeworks DTP* on the Atari ST. The author wrote his own conversion program to handle the differences in character sets between the ST and the Macintosh for its second incarnation, which was originally produced using a Macintosh IIfx. *Aldus PageMaker* was used for the layout and updating of text; *Aldus IntelliDraw* for the diagrams; Jeff Lewis' excellent shareware program *Imagery* was used for converting the Atari screen shots into Macintosh PICT format.

For the present PDF version, the files were converted to *PageMaker 7* (now Adobe) format and exported from there to PDF (all on a PowerMac G4—we've come a long way).

The original keycaps font referred to on page 3 was no longer available for this edition, and the author's own **Mac KeyCaps** font was used instead. That means that the keys look more like those on a Macintosh keyboard than those on an ST keyboard. In a few cases, such as  and , which don't exist in either font, the original graphics have been used, hence the mismatch of styles.

The front and back covers have been included in the PDF just for fun.

Finally, please note that some of the text is liable to be out of date—parts of it positively quaint—and certain sections such as **Appendix G: Future Plans** have been included mainly for historical interest. This page is the only new text in the publication. It is now many years since development of Fractal Music ST ceased, so please do not send in suggestions! The hoped-for Macintosh version has so far not happened—it still might, but it isn't looking terribly likely.

### COPYRIGHT/LICENSING

This copy of Fractal Music is now offered as freeware, However, this does not mean it is in the public domain: the program and manual remain...

copyright ©  datamusic 1993, 2001.

# CONTENTS

INTRODUCTION .....	2
TYPOGRAPHICAL CONVENTIONS .....	3
TIME DISPLAY .....	4
THE AUTHORS .....	5
COPYRIGHT/LICENSING .....	6
<b>1 GETTING STARTED</b>	
1.1 MINIMUM REQUIREMENTS: .....	11
1.2 FILES ON THE DISK: .....	11
1.3 SETTING UP AND REGISTRATION .....	12
<b>2 TUTORIAL</b>	
2.1 FOR ST NOVICES .....	15
2.2 THE PROGRAM .....	19
<b>3 THE MAIN SCREEN</b>	
3.0 THE DISPLAY .....	31
3.1 CHANGING THE TEMPO .....	32
3.2 THE CURSOR-BOX .....	34
3.3 MOVING AROUND THE SCREEN .....	34
3.4 CHANGING PARAMETERS .....	35
3.5 RANDOMISABLE PARAMETERS .....	36
<b>4 FRACTATION AND PLAYBACK</b>	
4.0 FRACTATION .....	38
4.1 PLAYBACK .....	39
4.2 THE STOP BUTTON .....	39
4.3 WHICH TRACKS CAN YOU FRACTATE? .....	40
<b>5 THE PARAMETER GRID</b>	
5.1 MIDI CHANNEL .....	41
5.2 THE LOOPS AND THE “HOW MANY”S .....	41

5.3	VERSION .....	43
5.4	PITCH LIMITS .....	46
5.5	STARTING PITCH .....	47
5.6	PITCH EXPANSION .....	47
5.7	VELOCITY LIMITS, STARTING VELOCITY, VELOCITY EXPANSION ...	48
5.8	RANDOMISING .....	48
<b>6</b>	<b>THE MENUS</b>	
6.1	DESK .....	49
6.2	FILE	
6.2.1	<i>Start new work</i> .....	50
6.2.2	<i>Loading</i> .....	50
6.2.3	<i>Saving</i> .....	51
6.2.4	<i>Delete file</i> .....	54
6.2.5	<i>Quit</i> .....	54
6.3	PRINT	
6.3.1	<i>All parameters</i> .....	55
6.3.2	<i>Tracks on only</i> .....	55
6.3.3	<i>MIDI data</i> .....	55
6.4	SELECTING TRACKS AND EDITING .....	56
6.5	TRACK	
6.5.1	<i>Protect</i> .....	59
6.5.2	<i>Unprotect</i> .....	59
6.5.3	<i>De-randomise trk</i> .....	59
6.5.4	<i>De-randomise all</i> .....	60
6.5.5	<i>Erase MIDI</i> .....	60
6.5.6	<i>Name track</i> .....	60
6.5.7	<i>Name work</i> .....	60
6.6	OTHER	
6.6.1	<i>Copy parameters</i> .....	61
6.6.2	<i>Event list</i> .....	61
6.6.3	<i>Check passes</i> .....	63
6.6.4	<i>Help</i> .....	64
6.6.5	<i>MIDI Thru</i> .....	65

<b>7</b>	<b>THE EDIT MENU</b>	
7.1	QUANTIZE .....	66
7.2	STRETCH/MOVE .....	69
7.3	INVERT .....	72
7.4	RETROGRADE .....	73
7.5	RETRO/INVERT .....	73
7.6	OTHER REFLECTS AND ROTATE .....	74
<b>8</b>	<b>KEYBOARD INPUT FOR TITLES</b> .....	<b>83</b>
<b>9</b>	<b>AUTOLOAD FILES</b> .....	<b>85</b>
<b>10</b>	<b>MEMORY RESTRICTIONS</b> .....	<b>86</b>
<b>11</b>	<b>NON-NOTE DATA</b> .....	<b>88</b>
<b>12</b>	<b>HINTS AND TIPS</b>	
12.1	MICROTONES .....	89
12.2	FRACTAL VARIATIONS .....	90
12.3	MORE VARIATIONS .....	91
12.4	UNFRACTAL MUSIC! .....	91
12.5	PITCH EXPANSION VERSUS STRETCH/MOVE .....	91
12.6	PERFECT SYMMETRY .....	91
<b>APPENDICES</b>		
A	PARAMETER REFERENCE GUIDE .....	92
B	KEYBOARD COMMANDS .....	94
C	EXTENDED ON-SCREEN CHARACTER SET .....	99
D	ABOUT MIDI FILES .....	103
E	TROUBLESHOOTING .....	107
F	GLOSSARY .....	110
G	FUTURE PLANS .....	116
<b>INDEX</b>	.....	<b>118</b>



## CHAPTER 1

# GETTING STARTED

### 1.1 MINIMUM REQUIREMENTS:

Atari ST computer\*

Monochrome or colour monitor

1 or more MIDI instruments (with appropriate amplification and leads)

Printer (optional)

\* *The program will load into half a megabyte, but this leaves very little working space. A minimum of 1 megabyte is recommended. See pages 66 and 91 for more about the memory.*

### 1.2 FILES ON THE DISK:

The disk is single-sided and contains these files:

- AUTOLOAD.FM1 Auto parameters file: *see* **Chapter 9**.
- DESKTOP.INF Standard boot-up system information file.
- FRACMUS.PRG The main program.
- FRACMUS.RSC The resource file required by the program.
- PREL2.MID A demonstration MIDI File (Prelude no.2 from *12 Little Preludes* by J.S.Bach).
- README.TXT This file may or may not be present. If it is, it will be a text file containing details of any changes that may have been made to the program since this manual was completed. From the desktop, double-click on the filename, then click on **SHOW** to see the text on the screen or **PRINT** to get a print-out you can keep with the manual.

### 1.3 SETTING UP AND REGISTRATION

First, *Datamusic* would like you to register your copy of **FRACTAL MUSIC**—indeed, you won't be able to use it until you have.

It is possible, depending on circumstances, that your copy will already have been registered when you receive it, in which case you can skip this step. If not, though, you must run the program once from the master disk, before you make a working copy. Put the master disk in the drive and switch on, then double-click on **FRACMUS.PRG** (“For ST Novices” in the Tutorial chapter explains about mouse clicking). You will be asked to enter your name and organisation or approximate location (eg “Captain Kirk”, “Datamusic Intergalactic” or “Alfred Prufrock”, “Scunthorpe”). This information will then be encoded into

```
FRACTAL MUSIC version 2.51
=====
Copyright © 1993 Datamusic

Please register this master disk
by entering your name and
organisation or approximate location

You are .....
of .....

>>> OK <<<
```

the program file itself, and when you subsequently run the program it will appear in the “About **FRACTAL MUSIC**” dialog box. You should also find a registration card with the package—it is in your interest to complete and return this as soon as you can.

*Whether you register FRACTAL MUSIC yourself or not, a unique serial number is encoded in the program file, and any illegal copies will also have this serial number, which can be traced back to you.*

Next, we strongly recommend that you make a working copy (see your ST Owner's Manual for how to do this, if necessary) and put the master disk away somewhere safe. The only two files which are absolutely essential for the program to run are FRACMUS.PRG and FRACMUS.RSC, but there's no problem with using desk accessories or an AUTO folder (including, for example, an improved file selector or a RAM disk if you have enough memory). It is essential that the two FRACMUS files are in either the root directory or the same folder—if you use an AUTOLOAD file, this must also be in the same directory or folder as the program. We recommend that, at least to begin with, you copy both AUTOLOAD.FM1 and PREL2.MID onto your backup for the purposes of the tutorial—you can always remove or replace them later.

The DESKTOP.INF file will automatically set your system to medium resolution if you are using a colour monitor, and shows the file directory in text form (the programmer's preference, but you can of course do your own "Save Desktop" operation to change that).

You may also like to create one or more folders for the data files you are going to create with **FRACTAL MUSIC**. Suggestion: make three folders, one for each of the file types—we work with folders called FRACMUS.ALL, FRACMUS.MID and FRACMUS.PAR, or you could call them ALLDATA, MIDIFILE and PARAMTER, or ... the possibilities are endless. If you are not using any other MIDI program (especially a sequencer), there's no point in using MIDI Files, as the program's own "ALL" format stores more information (and is faster). The ST Owner's Manual explains how to make folders.

Make sure you have everything set up as normal, then insert your working disk, switch on (or press the reset button on the back of the ST) and double-click on FRACMUS.PRG. This should take you into the program in the normal way, but if you hit any snags they should all be covered in **Appendix E** on troubleshooting.

Note for colour users: although the program was principally designed (and looks better) using a monochrome (high resolution) monitor, it runs perfectly well in colour, and colours have been incorporated to a fairly minimal extent. If you have the *Control Panel* desk accessory loaded, as soon as you open it from the **Desk** menu, the colours immediately revert to the default red and green (or whatever you last set). You can, of course, set the colours to whatever you choose (the program doesn't change them at any point), but if you wish to restore the program's original colours, make the following adjustments:

Set "red" to 7 (red slider), 4 (green) and 2 (blue).

Set "green" to 4 (red slider), 6 (green) and 7 (blue).

White and black stay white and black respectively.

If you do set your own colours, bear in mind that you'll need plenty of contrast between "red" and "green", otherwise the cursor-box (coming soon ...) will not show up clearly: keep "red" nice and strong and "green" fairly pale. The screen illustrations for this manual were produced using the *Snapshot* desk accessory on a monochrome monitor, so some of the proportions and other details will look slightly different—such differences will be pointed out where it's important.

Now the program has loaded successfully, on with the show ...

## CHAPTER 2

## 2

## TUTORIAL

In this chapter we hope to whet your appetite by showing you how to get something out of **FRACTAL MUSIC** immediately. This will be done without going into all the details (which will come later), and therefore with the minimum of fuss.

## 2.1 FOR ST NOVICES

If you are reasonably familiar with the general use of your ST, skip this and go on to “The Program”. For the novices, we will just explain a few basic terms and techniques associated with using the ST.

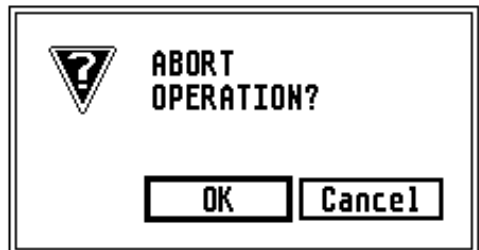

**Mouse clicking** Whenever you see the word **Click**, this means move the mouse pointer to that spot on the screen and briefly press one or both mouse buttons. Which button (or both) to **Click** is usually specified, but if not you can often use either left or right button. Where this does not apply is explained at the end of the introduction under “Typographical conventions”. Although you won’t need it much once you’re into the program, another common technique is “double clicking”. This simply means clicking twice, rapidly, on the left button—you have probably already done this to load the program. At many times in this program you can also *hold down* one of the buttons to prolong the effect that button has.

**Alert box.** You will see a lot of these in **FRACTAL MUSIC**, like the one shown here. It is a box which appears in the centre of the screen, containing a brief message and an “icon” (symbol) which is either !, ?, STOP or



possibly none at all. There are also one or more “buttons” to click on (most frequently “OK” and “Cancel”). **L-click** on whichever button suits your purpose. One of the buttons is always a “default” button (see below).

**Dialog box.** In the context of **FRACTAL MUSIC**, these serve more or less as elaborate, larger alert boxes, just giving information (in other programs you will come across more fully-fledged dialog boxes where you select options and even type things in—this isn’t necessary in this program as all those things are done in other ways). There is always an “EXIT” or “OK” button to get you out of it, and occasionally a “MORE” button to show you another dialog box.

**Default button.** Wherever you have one or more buttons to **Click** on, whether in alert or dialog boxes or in some other part of the program, if one button has a **thick** border, that is the default button. In every case, pressing  or  has the same effect as clicking on the default button. “OK” is the default in the example above.

**Menu selection.** Across the top of the screen at all times is this:

---

**Desk File Print Edit Track Other**

---

It is the “menu bar”, and to pull down one of the menus, move the mouse pointer up onto one of the menu titles and a list of items will drop down. If you do this by accident, you can get rid of the menu by **Clicking** anywhere *outside* it.



Any items shown in normal black type are available, but at certain times (*eg* during any of the edit functions) most of the items become “greyed out” (*ie*, shown in faint type like the dotted lines between some of the items). This means they are not available—try clicking on one and see what happens (it’s OK, it’s not dangerous). To select an item that *is* available, move the mouse onto it—it will go into “reverse video” (see below)—then **L-click** and the program will do whatever you’ve just told it to.

Don't worry if you don't *always* get a menu when you move the mouse up there: at certain times in the program you can't, but there are always good reasons for this.

There are utility programs available which alter the way in which the mouse and, particularly, the menus behave (eg, to imitate an Apple Macintosh). If you have one of these installed, the above will appear not to be absolutely accurate (but then, if you *have* installed such a program, you are probably the sort of techie who knows all this stuff anyway).







**The file selector.** When you are loading, saving (though not always) or deleting files, you will be called upon to use this. It shows a list of files currently on the disk, and asks you *either* to choose one from the list *or* to type in a filename.



It can show only a limited number of files at a time, so if there are more than that on the disk you can scroll through the list by using the “slider” (or its up and down arrows) immediately to its right. Any file name that has  on its left is a *folder*—to open it, **L-click** on it.

To select a file from the list, *either* double click on it *or* **L-click** once (you'll see the name appear in the selection box on the right) and **L-click** on “OK” (or press ). Alternatively you can type in a filename, though unless you're saving a new file it's easier (and more mistake-proof) to select from the list. If there's already a name you don't want in the box, press  (top left) and the box will clear. Then type in your filename, which can have up to eight characters, followed by a dot and up to three more characters—but it is important to get these last three right, because they signify the type of file. The characters can be letters, numbers or the underline symbol, but nothing else.

Again, there are utility programs around which enhance the operation of the file selector, but again, if you have one you presumably know how to use it.

---

**Modifier keys.** There are three (well, four actually, but one of them is a duplicate) keys which, when held down, affect what happens when one of the other keys is pressed. These are , , and . Whenever you are asked to press, for instance,  , this means hold down , press  then release both.

**Function keys.** These are the ten grey, slanting keys across the top of the keyboard. Whenever you are asked to press, for example, , this means the function key, not  followed by .

**Reverse video.** Or “in reverse” or “reversed”—a photographer would call it negative, *ie* black becomes white and vice versa. This technique is commonly used to highlight selected items in menus, etc., and has various other meanings in **FRACTAL MUSIC**.

## 2.2 THE PROGRAM

Assuming you have correctly loaded the program as described in “Getting Started”, follow the steps below for a quick whiz through some of **FRACTAL MUSIC**’s features.

2

- 1 Make sure you have a MIDI instrument connected properly and set to MIDI channel 1. For the present purpose choose a fairly standard sound that works well over a wide range and has a sharp attack, such as a piano-type sound.

For most of the remaining steps we will give *MOUSE* and *KEYBOARD* versions as described under **Typographical conventions**, though there’s no reason why steps from the two alternatives cannot be combined.

### 2 **Fractate** track 1.

*MOUSE*

**Click** on **Fractal**, the left-most of the three buttons in the top left hand corner of the screen.

*KEYBOARD*

Press  .

If the supplied AUTOLOAD file is on your disk you have just created a bit of music that, almost certainly, no-one has heard before—including other **FRACTAL MUSIC** users—because the parameters are randomised (to be explained in due course). A small triangle will have appeared to the right of track 1’s title and the first number in the grid (01) is now reversed. This means there is now MIDI data on that track, recorded on channel 1.



While the music was playing, you should have seen a little bell appear (where the triangle is now) every time a note sounded, and a box in the top right of the screen telling you which keys were available to you. Maybe you experimented with these—if you experimented with  it will have produced something different when it re-started. This is because the parameters were re-randomised (the reversed numbers would have changed). What’s more, some of the other numbers were doing a kind of count-down while it was running, though they’re now back to their original values. Again, all will become clear.

It's just possible that you didn't hear any notes and didn't see the bell. Don't worry about this—just try the fractation again. You'll see an alert box asking you if you want to replace track 1. Say "Yes" (see the paragraphs on Alert boxes and Default buttons above if you're not sure about this). The values are then re-randomised, giving you a new lot, and the odds against getting a second blank track are colossal.



If you didn't hear any notes but you *did* see the bell, something is wrong with your MIDI setup, so check it thoroughly and try again.



### 3 Play it back.

MOUSE	KEYBOARD
<p><b>Click</b> on the <b>Play</b> button next to the <b>Fractal</b> button (it has the standard arrowhead playback symbol you find on most tape recorders).</p>	<p>Press .</p>

You should have heard exactly the same again and seen a figure "1" where and when you saw the bell before. This means there is one note playing, as **FRACTAL MUSIC**'s initial output is always monophonic. Later you'll see how you can get polyphonic tracks appearing. You probably also noticed a similar box in the top right giving keyboard options, but this time,  would have produced the same music because you were only playing back—simply regurgitating what is already sitting in the memory. Also,  is no longer relevant and hence not offered.

### 4 Give track 1 a title, such as "Original".

MOUSE	KEYBOARD
<p>a <b>B-click</b> in the title area of track 1 and a box appears where you type in the title.</p>	<p>a Press  . As with the <i>Mouse</i>, if you haven't moved the cursor-box you'll be asked for track 1's title.</p>

- b If it already has a title such as “Random parameters” (as in the AUTOLOAD file), press  to clear it.
- c Type in your title (you are allowed up to 23 characters) and press .

b, c See *Mouse*.

Instead of **B-clicking** in the title area, you could select **Name track** from the **Track** menu. Assuming you haven’t done anything to move the cursor-box (coming soon), you’ll be asked for track 1’s title in the same way.





The title will appear in the correct place.

- 5 De-randomise track 1—don’t worry about why for now.

**MOUSE**

**KEYBOARD**

- a Select **De-randomise** track from the **Track** menu.
- b You’ll be asked which track you want to de-randomise. **Click** in the title area of track 1.

- a Press  .
- b You’ll be asked which track. Press main or num.

The numbers and notes along track 1’s line which were reversed are now displayed normally (but only if the AUTOLOAD file is on your disk—if not, they weren’t reversed to begin with and nothing will have happened).





- 6 Protect track 1, so that you can't destroy the data by mistake.

## MOUSE

- a Select **Protect track** from the **Track** menu.
- b You'll be asked which track. **Click** in the title area of track 1.

## KEYBOARD

2

- a Press  .
- b You'll be asked which track. Press  main or  num.







The number "01" to the left of track 1's title area will be reversed to show the track is protected.

- 7 Invert track 1, putting the inversion in track 2. We'll just use the default settings for now.

## MOUSE

- a Select **Invert** from the **Edit** menu.
- b You'll be asked which track you want to invert. **Click** in the title area of track 1.
- c You'll be asked where you want to put the result. **Click** in the title area of track 2.
- d When the inversion screen appears, just **Click** on OK—don't worry about what it all means for now.

## KEYBOARD

- a Press  .
- b You'll be asked which track. Press  main or .
- c You'll be asked where to put it. Press  main or .
- d On the inversion screen, press .

You'll see the same triangle as on track 1 appear on track 2. Also, the numbers and notes to the right of track 2's title should now be the same as those of track 1, with the first one (MIDI channel) reversed.







8 Solo track 2 and play it back.

MOUSE

- a **B-click** on the little arrow to the right of track 2's title area.
- b **Click** on the **Play** button (see 3).

KEYBOARD

2

- a Move the cursor-box onto track 2's arrow (to the right of the title) with the     keys—experiment with these if necessary.
- b Press num.
- c Press  (see 3).





Track 2's arrow will point upwards, and all the others down (previously track 1's arrow was up and the rest down). This means that track 2 is now on and the rest off. You will then have heard your original music upside down—*ie* where the notes went up before, now they go down, and vice versa.

9 Turn track 1 on and play both together.

MOUSE

- a **Click** on track 1's arrow.
- b **Click** on the **Play** button.

KEYBOARD

- a Move the cursor-box onto track 1's arrow.
- b Press num, num or num.
- c Press .

Both the top two arrows will point up. Now you've heard your original and its inversion as two simultaneous parts.

10 Give track 2 a title, such as "Inversion".

See 4 above for how to do this, substituting "2" for "1". If you use the menu or keyboard versions, make sure the cursor-box is somewhere on track 2's line.









11 Stretch track 2 to twice its length and put the result in track 3.

### MOUSE

- a Select **Stretch/Move** from the **Edit** menu.
- b When prompted, **Click** in track 2's title area.
- c When prompted, **Click** in track 3's title area.
- d When you see the edit screen, move the mouse to the "Expand or Compress" part of the display and **R-click** once on the digit "1" (not one of the "0"s) in the left half of the lower box, thus changing the Time ratio to 0002:0001 (if you overshoot and get a value of 0003 or more in this box, **L-click** or **L-hold** to bring it back down). You'll see one or both of the Event times change in the lower right part of the left display. Don't worry if this seems a bit confusing at first—bear with us.
- e **Click** on OK.

### KEYBOARD

2

- a Press  .
- b When prompted, press main or num.
- c When prompted, press main or num.
- d On the edit screen, press num. (This has no numerical significance as you'll see when we examine this function in detail).
- e Press .

Track 3 will now have a triangle, all the same values as tracks 1 and 2, and a reversed MIDI channel.

12 Solo track 3 and play it back.

See 8 above for how to do this, substituting “3” for “2”.

You will have heard the same as track 2, but at half the speed because all the time values have doubled.

13 Give track 3 a name, *eg* “Augmentation”, which is the technical term in music for this kind of thing.

14 Double the tempo and play track 3 again.







**MOUSE**

**KEYBOARD**

a Move the mouse to the Tempo display at the top of the screen and **R-hold**, or **R-click** repeatedly, on the number (120.00). The further to the left of the number you do this, the faster the value will change. Do this until you reach a value of 240.00.

If you overshoot, **L-click**-ing or **L-holding** will bring it back down (see 11). If you find it’s going too fast, move the pointer over the digits after the decimal point for the finest adjustment.

b **Click** on **Play**.

a Hold down, or press repeatedly, / main until the tempo value reaches 240.00.   will get you there faster, by coarser increments, and   will make finer adjustments. If you overshoot, all the above applies to  main for decrementing the value.

b Press .



This should now be identical to track

2 at 120.00 bpm (beats per minute).

- 15 To check this, change the tempo back to 120.00, solo track 2 and play.
- 16 Turn on tracks 1 and 3 and play all three together. This will begin to sound quite busy now until half way through when tracks 1 and 2 finish together, just leaving track 3 to finish solo.
- 17 Give the whole piece a title (if you can call it a “piece” just yet—still, it’s only an exercise).

**MOUSE**

**KEYBOARD**

- a *Either **B-click** in the title area above the **Fractal, Play** and **Stop** buttons (where it says either “Autoload File” or “Untitled” at the moment); or select **Name work** from the **Track** menu.*
- b When you get the input box, press  to clear the line, type in your title—only 16 characters are allowed for this one—and press .

- a Press  .
- b See *Mouse*.

The new title will now be where the old one was.

18 Save your work.

**MOUSE**

- a Select **Save all as ...** from the **File** menu.
- b The file selector will appear. Type in your file name and **Click** on OK or press . If in doubt about this, see the ST Novices' section above.

**KEYBOARD****2**

- a Press  .
- b See *Mouse*.

There will be a few moments' disk activity (with the busy bee in place of the normal mouse pointer), then the mouse pointer will be restored and your file is on the disk.

**NB** If you want to save your file on a *different disk*, refer to the detailed section on saving files (page 53) before you change disks.

Now you have actually created something, we'll have a quick look at a file that was imported from a sequencer and then had one of **FRACTAL MUSIC**'s more powerful and unusual editing functions applied to it. To do this, you will need the file PREL2.MID on your disk. If you didn't copy it onto the disk you're using now, skip to **23** and come back to this another time.

19 Load the demonstration MIDI File.

MOUSE

- a Select **Load MIDI file** from the **File** menu.
- b When you get the “Are you sure?” message, **Click** on “Yes”.
- c Select PREL2.MID from the list. If in doubt about this, see the ST Novices’ section above.

KEYBOARD

2

- a Press .
- b See *Mouse*—you can’t do this with the keyboard.
- c See *Mouse*.

Assuming the file’s there, you’ll see “Checking memory ...”, then “Reading format 1 file” on the screen. Ignore it for now—it’s just giving you information you don’t really need! This process will be a bit slower than saving because **FRACTAL MUSIC** has to do a lot of processing to convert MIDI File data into its own format, so be patient. Finally, a new set of 7 titles (including the main one) will appear, along with 6 triangles and reversed MIDI channels. None of the other values in the big grid will change though, because none of that data is stored in a MIDI File. All 6 of these tracks will be on. **Chapter 8** and **Appendix C** on keyboard input will explain how to get the non-keyboard characters (like °).



20 Play back tracks 1 and 2 only.

The only part of this we haven’t already done is turning tracks off, which we need to do to tracks 3, 4, 5 and 6.

MOUSE

Same as turning on—**Click** on the arrow and it changes direction.

KEYBOARD

Press ,  or  with the cursor-box on the arrow.

The quick way, though, is to solo track 1 or 2 and just turn the other one on.

You will now hear J.S. Bach's *Prelude no.2* (from *18 Little Preludes*) in its original form. Notice that now you are seeing different numbers appearing in the title boxes, showing how many notes are playing at any point.

## 21 Play back tracks 3 and 4 only.

This demonstrates what happens when you *rotate* Bach through  $15^\circ$ . The right hand is rotated anticlockwise and the left hand clockwise. The result, we think you'll agree, sounds pretty unusual—one might even make so bold as to suggest that old Johann's rotated at least  $15^\circ$  in his grave ...

## 22 Play back tracks 5 and 6 only.

This time it's  $45^\circ$ , clockwise and anticlockwise—though it's been centred and folded too. Don't worry if nothing happens for a while (it won't): one result of this particular transformation is that the beginning of the piece gets delayed. Baffled? Persevere and it'll all become clear, though admittedly some of the musical results you get from **FRACTAL MUSIC** aren't for the faint hearted.

***A curious phenomenon:** when rhythmically quantized music is rotated, the rhythm appears to “fall apart” and become seemingly random—**except** when the rotation is through  $45^\circ$ , at which point the rhythm becomes re-quantized at a tempo 2 times the original tempo.*

You could also try playing back different combinations of these 6 tracks, though you'll have realised by now (if only from the titles) that the odd tracks are the “top half” of the piece and the even tracks the “bottom half”. How about trying all 6 together? Yes, but your MIDI instrument may well not be able to handle that many notes at once—in fact if it's 8-note polyphonic (which many reasonably cheap ones are) it isn't playing all the notes just in the  $45^\circ$  version. If you've got the necessary hardware, you may want to come back to this file when you know how to set different MIDI channels—perhaps you've already worked this out (it's not difficult), but everything in its proper place and all that.

- Later on in this manual, you will find out how to carry out rotations like these yourself (rather than just loading “one we prepared earlier”).

- 23 If you feel ready to start something fresh, clear out all the data ... but first, have you noticed how the “Memory used” line (under the operating buttons) has been changing (and the vertical bar in the extreme top left filling up) during this exercise? It also changed its function temporarily while you loaded the MIDI File—more about this in the section on the **File Menu**.

**MOUSE**

**KEYBOARD**

- a Select **Start new work** from the **File** menu.
- b On the “Are you sure?” message, **Click** on “Yes”.

- a Press .
- b See *Mouse*.

The display should return to exactly the same state as when you first loaded the program, *ie*, if an **AUTOLOAD** file is present on the disk, it will be re-loaded and all the parameter values stored in it will be displayed; otherwise all the parameters will revert to their default values. The memory display should once again show “000%”.

You should now be ready to work through the rest of the manual to learn in detail what all **FRACTAL MUSIC**'s many features have to offer, and how to use them.

CHAPTER 3

THE MAIN SCREEN

3.0 THE DISPLAY

Desk File Print Edit Track Other

Autoload file		Tempo		MIDI channel	Loop 3	A how many	Loop 2	A how many	Loop 1	A how many	Number of inner loops	Version	Lower pitch limit	Upper pitch limit	Starting pitch	Pitch expan.	Lower velocity lim.	Upper velocity lim.	Starting velocity	Velocity exp.			
			120.00																				
Memory used: 000%		per minute																					
01	Random parameters			01	72	03	27	03	02	03	005	5	C	-1	C	6	5	4	9	001	127	162	4
02				01	01	03	01	03	01	03	005	A	-1	C	7	C	3	4	001	127	064	4	
03				01	01	03	01	03	01	03	005	A	-1	C	7	C	3	4	001	127	064	4	
04				01	01	03	01	03	01	03	005	A	-1	C	7	C	3	4	001	127	064	4	
05				01	01	03	01	03	01	03	005	A	-1	C	7	C	3	4	001	127	064	4	
06				01	01	03	01	03	01	03	005	A	-1	C	7	C	3	4	001	127	064	4	
07				01	01	03	01	03	01	03	005	A	-1	C	7	C	3	4	001	127	064	4	
08				01	01	03	01	03	01	03	005	A	-1	C	7	C	3	4	001	127	064	4	
09				01	01	03	01	03	01	03	005	A	-1	C	7	C	3	4	001	127	064	4	
10				01	01	03	01	03	01	03	005	A	-1	C	7	C	3	4	001	127	064	4	
11				01	01	03	01	03	01	03	005	A	-1	C	7	C	3	4	001	127	064	4	
12				01	01	03	01	03	01	03	005	A	-1	C	7	C	3	4	001	127	064	4	
13				01	01	03	01	03	01	03	005	A	-1	C	7	C	3	4	001	127	064	4	
14				01	01	03	01	03	01	03	005	A	-1	C	7	C	3	4	001	127	064	4	
15				01	01	03	01	03	01	03	005	A	-1	C	7	C	3	4	001	127	064	4	
16				01	01	03	01	03	01	03	005	A	-1	C	7	C	3	4	001	127	064	4	

This is where you'll be much of the time, so here's some more detail about what's there.

In the top left-hand corner are the main title, operating buttons, memory status (and file operation progress) display and tempo display. The three operating buttons are **Fractal** and the standard **Play** and **Stop** symbols used on tape recorders. All this should be familiar by now, but perhaps we should explain one apparent anomaly. The **Stop** button is really there for show as much as anything; you can never actually click on it. This is because **Fractation** and

**Playback** work more efficiently if the mouse is disabled, so you can only **Stop** from the keyboard.

Below these are the 16 track numbers and titles, with which you'll also be familiar. In the provided AUTOLOAD file, only track 1 has a title—a highly imaginative one, we think you'll agree. This is also where the on/off arrows and the various symbols associated with MIDI data appear: bell, numbers, triangle and the “congruence” symbol ( $\equiv$ ). You may not have seen this last one yet. It appears during **Playback** if an empty track is turned on, to tell you there's nothing there to play.

You should already have tried the three possible ways to edit the main title, or add or edit a track title. If not, refer back to the Tutorial, exercises 4 and 17.

### 3.1 CHANGING THE TEMPO

For the general principal, see **Changing Parameters** below—and you should have tried it by now in the Tutorial. The tempo is a little different from the other parameters, though, because the values don't change by regular increments—it's best to experiment to find out what happens, but three mouse positions have different effects: anywhere to the *left* of the units column, *on* the units column, or to the *right of the decimal point* for really fine adjustments.



When we began work on **FRACTAL MUSIC**, and before we changed to the general MIDI File standard, we were working towards a specific compatibility with the Hybrid Arts *SMPTEtrack* sequencer: the available tempi in **FRACTAL MUSIC** therefore coincide exactly (except that our range is a bit wider) with the *high-resolution* tempi in *SMPTEtrack*. This seemed like a sensible range of tempi to use, with exact logarithmic relationships between them, so we stuck to it. The higher you go, the greater are the differences between adjacent values, which is all to do with those logarithmic ratios. The two decimal places you see on the screen are rounded values for display purposes—some, like 120.00, are exact, but some are in reality much longer numbers.

Here is the top left-hand corner of the display, showing a new title for the “work”, the tempo, some track titles, the triangles that tell you those tracks

contain some MIDI data, and the MIDI channels those tracks have been recorded on, also the fact that 2% of the available memory has been used. Note that only track 5 has no title and is turned off.

139¼° ↗ Nörth		Tempo	MIDI channel
rac tal	▶	160.00	
Memory used: 002%		J per minute	
01	Xylorimba	△↑	01
02	Clarinet	△↑	01
03	Harp	△↑	04
04	Vibes	△↑	05
05		↓	06
06	Bassoon	△↑	07

3

**NB** For those unfamiliar with MIDI: You can produce a number of different sounds simultaneously (as implied here) only if you have several instruments, or a multi-timbral instrument.

In the right-hand part of the screen is the main Parameter Grid and its headings. What it all means will be detailed in **Chapter 5**, but it is arranged in logical rows and columns so that, for instance, Track 3's parameters are all to the right of its title, and the Starting Pitch parameters for the 16 tracks are in a column below that heading.

**For colour users:** these headings will not fit on a medium resolution screen, so they are shortened to: MIDIch, Loop 3, ^ no., Loop 2, ^ no., Loop 1, ^ no., Inner loops, Ver., Bottom pitch, Top pitch, Start pitch, P exp., Bottom vel., Top vel., Start vel., V exp.

As you will have seen, all the tracks except track 1 are the same when you first load with the supplied AUTOLOAD file. Even track 1 is the same as the rest if there is no AUTOLOAD file. These are the *default* settings.

*That word “default” is going to crop up a lot. In case it’s an unfamiliar bit of jargon, it simply means a value that is already set before you do anything to it.*

3

... and yes, it’s a bit of a boggling array of numbers to start with, but you’ll get used to it.

## 3.2 THE CURSOR-BOX

The little box round track 1’s on/off arrow in the picture on page 31 is the cursor-box. This indicates which track and parameter is currently selected.

**For colour users:** your cursor-box fits exactly on the grid lines, instead of overlapping them as in the picture, but is in a contrasting colour (as set up in the program, bright red against a pale blue grid). See note on page 14.

## 3.3 MOVING AROUND THE SCREEN







Whatever parameter you want to change must be the one inside the cursor-box (which automatically changes size to fit each parameter).

001	127	108
016	096	020
001	127	064

### MOUSE

See **Changing Parameters** below. As soon as you **Click** anywhere in the grid, the cursor-box will jump to the spot where you **Click**d as if by magic, so no separate operation is needed to move it.

### KEYBOARD

Logically enough, the arrow keys (just below  and ) move you about. The cursor-box also “loops” at the top, bottom and sides:  from the on/off arrow takes you to velocity expansion,  from velocity expansion returns you to on/off,  from track 1 gives you track 16, and  from track 16 gives you track 1.

### 3.4 CHANGING PARAMETERS





#### MOUSE

If you've used much of the MIDI software available for the ST, you'll be familiar with this technique. To change a parameter's value **R-click** on the parameter to raise the value, or **L-click** on it to lower it. In some software this is the opposite way round—sorry, but there is no standard, so you'll just have to get used to it. We've chosen this way round because we think **R**aise and **L**ower is easy to remember (OK, you could have **R**educe and **L**ift, but we reckon it's **L**ess **R**ememberable).

If you hold down the button, the value will go on up or down until you let go or it reaches its pre-ordained limit (which will all be detailed in due course), at which point it'll ring its bell at you. However, if the mouse is on the on/off arrow (there are only two possible states for this parameter), either button acts as a “toggle” and reverses the on/off state of the track.

In some boxes, you can point at the tens (or hundreds or, for note-names, octaves) column to change the value by a larger increment.

#### KEYBOARD

The num and num keys are equivalent to the right and left mouse buttons respectively. The same keys with  give you a larger increment, and num and num give you the minimum and maximum values respectively that are available for that particular parameter.

It may seem more clumsy to have separate operations for moving the cursor-box and changing values, but you might well find that you prefer the keyboard for some operations, hence the choice. Moreover, the mouse doesn't offer any way of getting straight to the minimum and maximum values.

3

### 3.5 RANDOMISABLE PARAMETERS

You may have been wondering why some of the headings are in reverse video—no, it's not just for pretty. The parameters with a reversed heading can be randomised by you. To do this:

3

<i>MOUSE</i>	<i>KEYBOARD</i>
<b><i>B-click</i></b> on the chosen parameter.	With the cursor-box on the chosen parameter, press <input type="checkbox"/> num.

A random value will appear, and be shown in reverse. If you ***B-click*** or press num on any other parameters (except the on/off arrow or MIDI channel—see below), either nothing will happen, or it'll respond to the first button that goes down if they're not quite together.

As you should already have discovered, ***B-click*** or num on an on/off arrow solos that track, *ie*, turns that track on and all the others off.

As you know, **Fractating** reverses the display of the MIDI channel of the **Fractated** track. This doesn't mean it's been randomised (the value hasn't changed). It means that your MIDI data on that track has been recorded on the MIDI channel you set. You can play it back on any channel you like (if you have the necessary MIDI hardware, of course), but when it's saved on disk it'll be the recorded channel that's in the data.

To change the playback channel, see **Changing Parameters** above, but ***B-click*** or num has a different effect. If there is MIDI data recorded on that track, this automatically resets it to the recorded MIDI channel (this can be handy for checking which channel you recorded a track on); if there is no data there, it just reverts to channel 1.

**NB** If the track was imported from a sequencer and contains data mixed from more than one MIDI channel, the channel of the *first event* on the track will be the one displayed and the whole track will play back on whichever channel you set.

Here are some parameters that have been altered ...

Loop 3	A how many	Loop 2	A how many	Loop 1	A how many	Number of Inner loops	Version	Lower pitch limit	Upper pitch limit	Starting pitch	Pitch expan.	Lower velocity lim.	Upper velocity lim.	Starting velocity	Velocity exp.
02	03	74	03	25	03	005	B	A -1 C	7	E 5	1	001	127	028	2
22	03	61	03	23	03	005	A	C 0 C	5	G# 2	5	012	108	085	4
25	03	43	03	01	03	005	A	A# 1 A	6	A 5	3	001	127	108	1
61	03	46	03	74	03	005	C	A -1 C	7	D 3	6	016	096	020	7
01	03	01	03	01	03	005	A	A -1 C	7	C 3	4	001	127	064	4
02	04	08	02	17	03	006	B	F# 2 C	5	B 3	9	001	127	033	3

## CHAPTER 4

# FRACTATION AND PLAYBACK

4



### 4.0 FRACTATION





So what is this curious word? We at *datamusic* have coined this word as an alternative to the more mundane “processing”. It means generating **FRACTAL MUSIC**, which is this program’s unique feature. For the moment, suffice it to say that this is the part of the program where the fractal mathematics (referred to in the introduction) is used to generate new music. The details of what is happening will be more fully explained in the next chapter.

If you have followed the tutorial, you should now have some idea what the **Fractal** button does—yes, it **Fractates**. You will also have seen the numbers of loops counting down so that you can follow its progress and have some idea of what’s going on. You will have seen too that the cursor-box and mouse pointer both disappear, and you are shown, in the top right-hand corner of the screen, the keyboard options available to you. These are:





Stop / Keep	:	RETURN / ENTER
Stop / Not Keep	:	UNDO
Abandon / Re-start	:	SPACE BAR
Pause	:	TAB / ESC

Here is what happens in response to each of these:



-  or  will interrupt the **Fractation** and keep what you’ve got so far in the track (the triangle appears).
-  will interrupt and abandon the data, as if you’d never started (no triangle).

- ⇒  has the same effect as , then  . This is handy when you are trying out random parameters because they are re-randomised each time you do this. If you aren't happy with the sound of what is emerging, just keep pressing  until you are.

There are two pause options because there's a difference between them:

- ⇒  will pause the music and *take all notes off*.
- ⇒  will pause the music and leave sounding any notes that are currently on. Pressing  in a rest, therefore, has the same effect as .

4

In both cases, the word “Pause” in the display changes to “Continue”, and  or  will make the program do just that.

### 4.1 PLAYBACK

As with **Fractation**, you should already have tried this. You have nearly the same keyboard options as with **Fractal**, except that  no longer applies: when you stop, *you are not deleting any MIDI data*, you just stop playing it. In place of the bell you saw when **Fractating**, you will see a number—this tells you how many notes are on at any moment. If you are playing a track you have just **Fractated**, without doing anything to it, this will always be a 1, but after editing (or with material imported from a sequencer), it might be any number. In the unlikely event that there are more than nine notes sounding, it shows various other characters which will be familiar to computer buffs who know about ASCII codes—in general, it means you have too many notes on!



**NB** In **PLAY** mode, the parameters you have set no longer have any effect—they only apply to **Fractating**.

### 4.2 THE STOP BUTTON

At the end of the fractation or playback (or when you interrupt it), the Stop button will be reversed for a moment, then all buttons return to normal display. When you pause, the Stop button is reversed *as well as* the Fractal or Play button until you continue.

### 4.3 WHICH TRACKS CAN YOU FRACTATE?

Whether you choose **Fractal** or **Play**, it will do it to any tracks that are *on* (all 16 if you really want), but with certain provisos in the case of **Fractal**:

- If a track is on, but already has something on it, you will get an alert box saying that there is MIDI data present on that track. You will be asked whether you want to replace it: answer Yes and it will re-**Fractate**; answer No and the track will automatically be turned off.
- If a track is on but *protected* (you should already have tried this), you won't be allowed to **Fractate** it at all—you will have to unprotect it first (same as protecting, but with   on the keyboard).
- In some more extreme circumstances, you may get a message to the effect that there is not enough memory, but that will be dealt with in **Chapter 9**.
- Finally, if a track is on and has any randomised parameters (shown in reverse), these parameters will be *re-randomised* when you **Fractate** again—*ie*, they'll still be reversed and the values will change. You already know how to de-randomise in case you've become particularly attached to those parameters.

## CHAPTER 5

# THE PARAMETER GRID

### 5.0

In this chapter, we'll look at each of the parameter columns in turn, explaining their significance and use—in considerable technical detail where appropriate.

5

### 5.1 MIDI CHANNEL

MIDI channels go from 1 to 16 (unless you use one of the various MIDI expansion devices which give you extra banks of 16 channels, none of which is supported by **FRACTAL MUSIC** at present). Each channel carries information separately from the others. Suppose, for example, that you have two MIDI instruments (or one that can handle more than one channel at a time), set to channels 1 and 2 respectively, with a different sound on each. **Fractate** a track on channel 1 and, as it runs, you will hear it with the first sound. If you then change the MIDI channel of that track to 2 and play it back, you'll hear the same music (the same MIDI data), but with the second sound. You could even copy the track (there are ways to do this, even though there is no specific “copy MIDI” function) and play it back through both channels simultaneously, giving a more complex aggregate sound.

### 5.2 THE LOOPS AND THE “HOW MANY”S

OK, now it's time for the heavy technical stuff—if you don't feel up to it just yet, skip to **Pitch limits** ...

Feeling brave then? Well, as mentioned briefly in the introduction, a *3-dimensional* process is going on here (remember those graphs from maths at school with horizontal (*x*) and vertical (*y*) axes? Add a *z* axis going towards/away from you and you've got the idea—see the illustration over the page). In musical terms, the 3 dimensions represent time (*x*), pitch (*y*) and velocity (*z*).

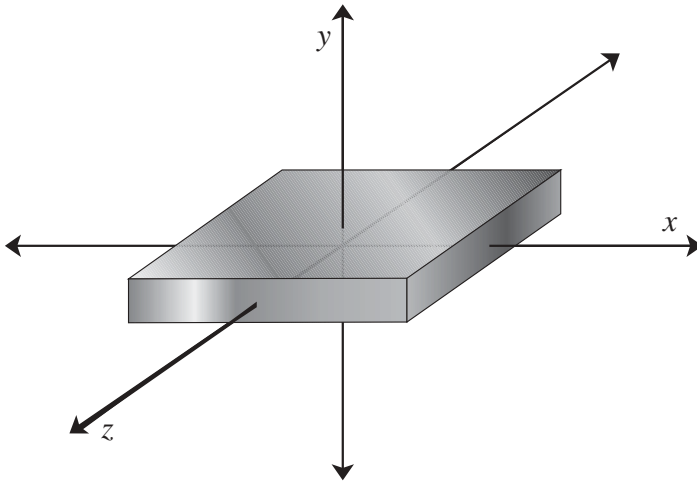

5

*If MIDI-speak is new to you, “velocity” means how hard the key was hit on the keyboard instrument, ie, (usually) how loud the note comes out (what is actually measured electronically is the speed at which the key went down—hence the name). This value, like the note itself, can be received from an external source—such as **FRACTAL MUSIC**—via **MIDI**.*

What actually happens is that this *cyclical* mathematics goes on a certain number of times, the number having been determined by *you*. Each time it happens, all three values are changed (hence the different notes, durations and loudnesses). If we start by concentrating on **Loop 1**, which is the innermost of the three, the number of times this process happens is shown in the **how many** box to its immediate right (3 by default). At the end of these, all the values are reset to something like their original values (but not quite), and the process starts again. So far, so good. Now, *all this* happens the number of times shown in the **how many** box to the right of the **Loop 2** column, that being the next one out, and—you’ve already got there, of course—*all that* happens the number of times set for **Loop 3**. So the default values of 3 in each box give  $3 \times 3 \times 3 = 27$  passes, which isn’t very many (each pass will produce either one note or a rest, and they’re often very short).

In fact, we lied a bit: there's another loop, which the perceptive will have spotted already, called the **Inner loop** because that's what it is. This is where the repeated "iteration" (one of the buzz-words in the world of fractals) really happens. Notice it has 3 columns instead of 2—that means the limit is 999 (more about that later). The values are reset as described above after the total number of inner loops, each time through all the other loops. With the default value of 5, that makes  $5 \times 27 = 135$  passes, which actually gives you a good few seconds' music. Each of the three outer loops can be set for values of 1 to 99.

So what about **Loops 1, 2 and 3** themselves? In each of these columns you can also choose a value from 1 to 99, which actually determines the starting value of our notional  $z$ ,  $y$  or  $x$  respectively. In other words, the music that comes out is different for every value—a total of  $99 \times 99 \times 99 = 970,299$  different combinations (and that's only a fraction of it, as you'll realise from further reading). The inner loop has no such starting value, as it's only a number of times something happens and doesn't represent any musical parameter.

5

***In case you're curious:** we did originally label **Loops 1, 2 and 3** as "Velocity loop", "Pitch loop" and "Time loop" respectively, because their values are directly related to those attributes of the notes produced. We realised, however, that this is not perceptible to you, the user, and that those headings might in fact confuse: hence the change.*

***For those who know about fractals:** this process is, in fact, a proper feedback loop: each value of  $x$ ,  $y$  and  $z$  produced is fed back into the equations in such a way that each of the three new values resulting from the next iteration depends on all three of the previous values.*

If you're now dreadfully confused and thinking "Why on earth did I buy this?", just experiment with changing some parameters and see what comes out when you **Fractate**.

### 5.3 VERSION

This, you'll be relieved to know, is the last parameter directly concerned with the mathematics. If you've read about the loops, you might be wondering why you don't always get an entirely continuous stream of notes—where do the rests (gaps) come from?

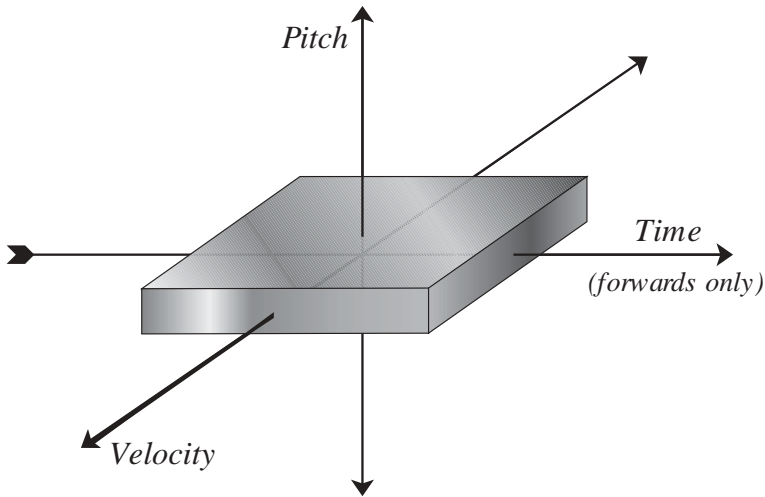

The values of good old  $x$ ,  $y$  and  $z$  produced after each calculation can be higher or lower than the previous value. Pitch or Velocity values can, of course, change in either direction ( $y$  can go down as well as up, just like interest rates). But what happens if the  $x$  value moves to the left? Time (at the moment of going to press) can only go forwards, so **FRACTAL MUSIC** cheats a bit: if a positive value is produced, it plays a note for that duration, as you'd expect ... but if a negative value results, it is changed to a positive value, but with *no note*, hence the rests (unless you selected Version C, which we'll come to shortly).

In fact, with some combinations of parameters (and Version A or B) you get very few notes indeed—it is even theoretically possible to get no notes at all (see the **Tutorial**, exercise 2): if this happens, don't worry, it doesn't mean the program's crashed; though it might be worth making a note of the parameters so you can avoid that “null” combination in the future.

Yes, but we still haven't really explained **Version** yet, have we? Simple: between Version A and Version B the sign of  $x$  is changed—*ie*, rests become notes and vice versa, so you can produce that continuous stream of notes as follows: set the parameters of two tracks to be identical (as most of them are when you first load)—you can use **Copy Parameters** for this (see page 63), then make sure one track is set to Version A and the other to Version B. **Fractate** and you'll get all

the gaps in each track filled in by the other (didn't work? Check both tracks are *on!*) ... at least, that's what you used to have to do until the obvious hit us: we added Version C, which is a combination of A and B and thus continuous, though really it's even more of a cheat as far as the true fractal process is concerned.

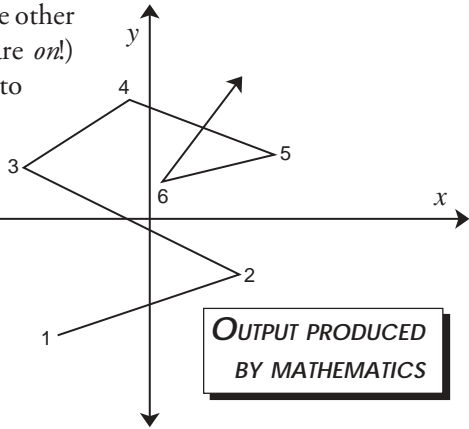

5

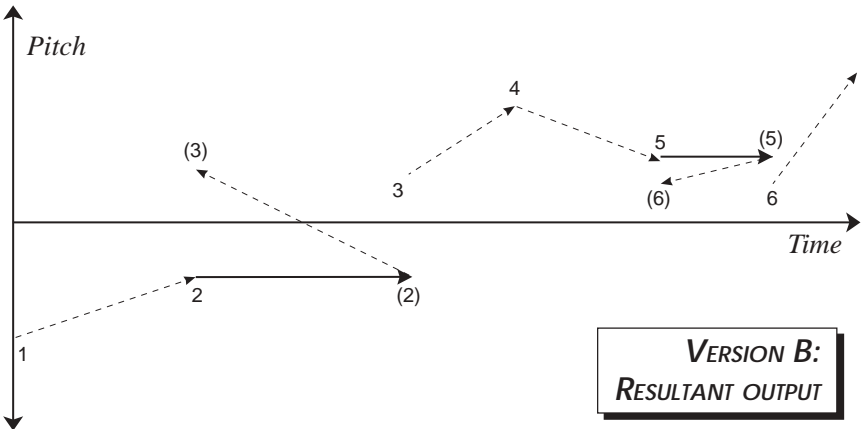
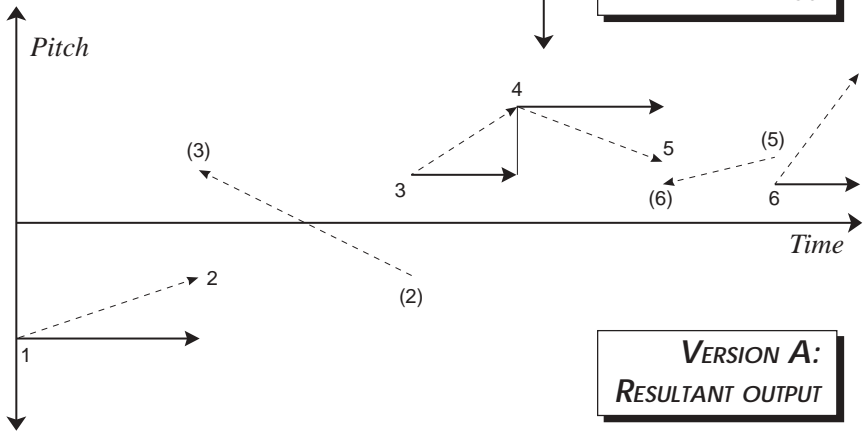

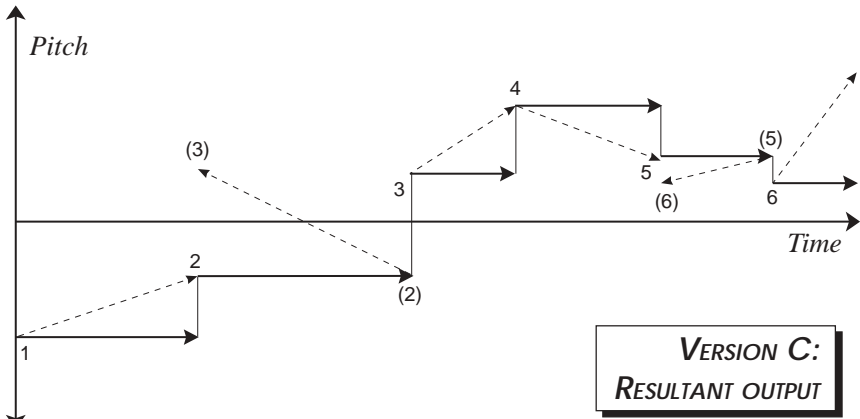

It starts to get easier now ...

## 5.4 PITCH LIMITS

You may decide that the sound you are using works best between certain notes—very few work well over the entire 10½ octaves available to MIDI. You can therefore use these parameters to limit the output to your chosen range.

If you're unfamiliar with MIDI jargon, this notation is standard: a note-name and an octave number which changes at each C (as you go up), so the note above A#4 is B4, followed by C5, C#5, and so on (the flat symbol isn't used because introducing such an alternative would make life far more complicated, and anyway “#” is a standard character for computers). Middle C is C3, and the whole range goes from C-2 to G8. **RACTAL MUSIC**'s default limits, A-1 to C7, give the range of a normal grand piano. Most 5-octave synthesizer keyboards go from C1 to C6, though some manufacturers' octaves are out of step with this (eg, middle C on Roland instruments is called C4).

***For the technically minded:** How does the output actually stay within these limits? Certainly, the mathematics knows (and cares) nothing about this. Suppose a rising series of notes is being produced, approaching the upper limit. When this limit is crossed, the program makes the note “bounce off” this limit. For example, if your upper limit is G6, and the program generates an A#6, what comes out will be an E6 (the same*

*interval the other side of G6). Thus, if you alter your limits you'll probably get different music. You can think of any notes outside your limits being "reflected" or "folded back" into the range, and if that folding takes it beyond the limit at the other end, it gets folded again—as many times as is necessary to keep it in range.*

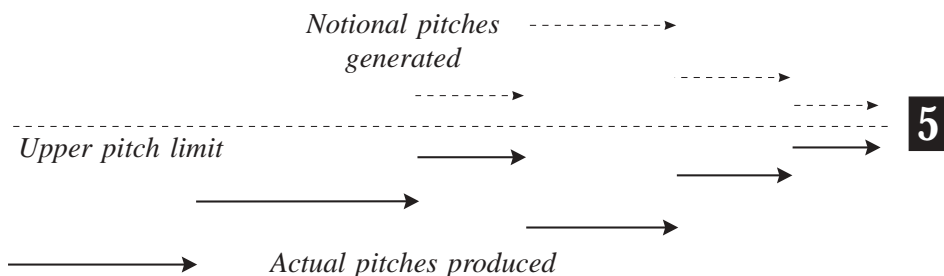

### 5.5 STARTING PITCH

This is, as you would expect, the note you choose for the first output from the processing. All subsequent pitches are relative to this note. The only catch is that if the resultant music starts with a rest (a negative  $x$  value—see **Version**, above), you won't actually hear this note. The diagrams for Versions A and B on page 47 should make this clear. Try setting two tracks to identical parameters, but with different starting pitches (say C3 and D#3, a minor 3rd apart): the result is two lines in rhythmic unison, a fixed interval apart. The default value for this parameter is C3 (middle C).

### 5.6 PITCH EXPANSION

The actual numbers (or, rather, the differences between consecutive numbers) produced by the processing at the core of the program tend to be very small values (less than 1). These have to be multiplied by something to make whole numbers, which are the only sort that MIDI understands. We decided to add to the flexibility of the program by letting *you* determine the extent of this multiplication: the higher the expansion number, the wider the intervals produced. The lower limit is 0, which will repeat the same note in the rhythm

determined by the processing (this can be good for use with percussion samples or drum machines, for example). The top limit is 9, producing very “leapy” music which will rapidly cover the whole range. The default setting is 4, about midway. Try, as above, two lots of identical parameters with just the **Pitch expansion** varied—this can give quite exciting results, with rhythmic unison but ever-changing intervals between the two lines.

### 5.7 VELOCITY LIMITS, STARTING VELOCITY, VELOCITY EXPANSION

All these work exactly the same way as for pitches. The default limits give the maximum available range, 1 to 127 (0 is not allowed, because MIDI interprets a note on with a velocity of 0 as a note off). The default starting velocity is 64, exactly midway, (usually taken as *mf* or *mp*), and the default expansion is 4.

5

One other thing about the limits for both pitch and velocity: if you change either of the limits so that your chosen starting pitch or velocity would then lie outside the range, the starting value is automatically adjusted to be the same as that limit’s value. Try it and see. Naturally, you aren’t allowed to set a low limit above a high limit or a high limit below a low limit.

### 5.8 RANDOMISING

As you know, any parameters with a reversed heading can be randomised as described in **Chapter 3**.

- **Loops 1, 2 and 3** will give values from 1 to 99.
- **Version** will just give A or B (C is regarded as a special case and can’t be obtained randomly).
- **Starting pitch/velocity** will each give a random value anywhere between the limits you have set. As above, though, if you then change a limit beyond this starting value, the start value will change with the limit, and it will be *automatically de-randomised* (and un-reversed on the screen).
- **Pitch/Velocity expansion** can both be randomised, but a pitch expansion of “0” is another non-randomisable special case.

## CHAPTER 6

# THE MENUS

**Desk File Print Edit Track Other**

---

### 6.0

In all except the **Desk** menu, you will find keyboard commands to the right of nearly every menu item, which you can use to access that function without going to the menu.

6

### 6.1

This is the normal type of **Desk** menu:  
**FRACTAL MUSIC** shows the title box on the first page of this manual (but with *your* registration information), and below that are any desk accessories (up to 6) that you loaded at boot-up time.

**Desk**

**FRACTAL MUSIC**

.....

**Mouse Speed  
Snapshot  
Control Panel**

We have tested a number of accessories with the program, including the three shown in this picture of the menu, and so far the program has behaved in a perfectly satisfactory manner with all of them.

The accessory *Snapshot* was used to produce all the screen illustrations in this manual.

## 6.2

This is also the usual sort of thing:

**6.2.1 Start new work** reloads the AUTOLOAD file if it is present; otherwise it initializes all the parameters to their default state. Either way, this command clears out any MIDI data you have created. You will be given this option first ...



**6.2.2** There are 3 different options for **Loading** files:

- **Load parameters** lets you do just that. You can load them from a parameters-only file (file extension .FM1) or from an “all” file (.FM2)—these are **FRACTAL MUSIC**’s own two file types. No MIDI data will be loaded with this option.
- **Load all** will load *only* from a .FM2 file, and loads the parameters and the MIDI data.
- **Load MIDI file** allows you to load MIDI data from a file created either in **FRACTAL MUSIC** or in another program that supports MIDI Files. The program looks for the first 16 tracks that have any MIDI data in them and puts them in its own 16 tracks. If there are fewer than 16, it puts the first in track 1 and continues until there are none left. It will also load the tempo, the time signature (though this is irrelevant to

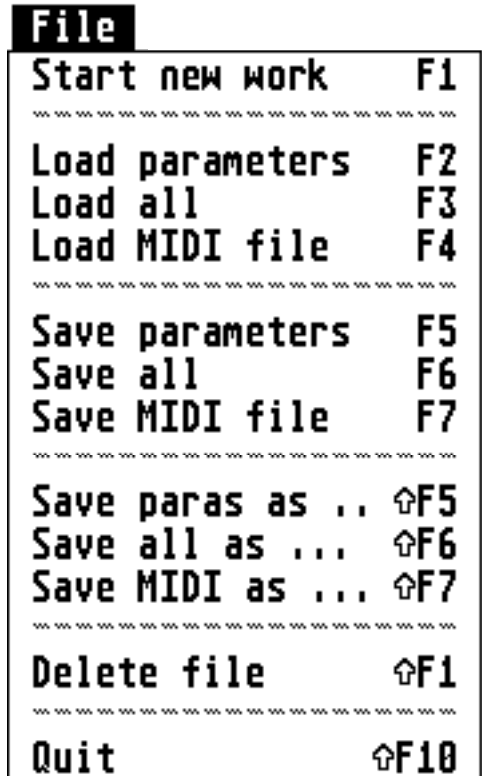

6

**FRACTAL MUSIC**), the main title and (format 1 only—see **Appendix D**) the track titles.

If there are more than 16 tracks in the MIDI File, you will be told so when that point in the process is reached.



With all 3 **Load** options, you will get the same alert box as when selecting **Start New Work**.

If you select a file with the wrong extension, you will get the message on the left, and if the file is not on the disk, you'll get the one on the right ...

6

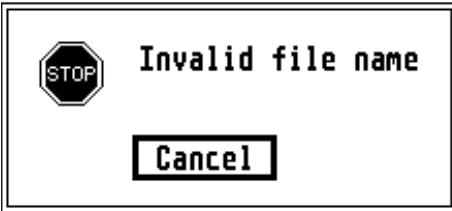

If you are loading a MIDI File and it turns out that the file is not the right sort, you'll get the message on the left below and if it *is* a MIDI File, but format 2 (rather than 1 or 0), you'll get the message to its right (see **Appendix D**):

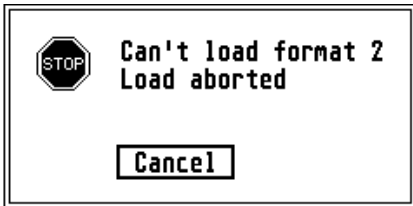
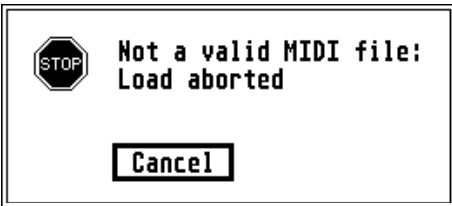

6.2.3 Then there are 6 **Save** options:

- The **parameters** and **all** options are as for **Load**, creating .FM1 and .FM2 files respectively.
- The **MIDI** options save a MIDI File which can be used in another program. Any tracks turned *on* and with MIDI data recorded will be saved in the MIDI File. The main title and track titles will also be saved, as will the tempo.

- The **Save as ...** options force the file selector to appear, letting you type in a filename and save different versions of your work under different names. This also happens the first time (after running the program) that you select the straight **Save** options, but after that, these options just update the same file. Whenever a file is replaced with the same filename, a backup file is automatically created.

If you type in a filename with no extension, or the wrong extension, the program automatically changes it to the correct one (.FM1, .FM2 or .MID).

If there isn't enough room to save your file on the disk, the program will tell you so (it checks first, unlike some programs!) ...







6



... or, if you are replacing an existing file, and there is room only if the old file is deleted first (thus sacrificing the backup file that would normally be created), the program will ask you this:



During all **Loading** and **Saving** operations, the memory display in the top left corner of the screen takes on an alternate role. The vertical “thermometer” fills up to show the progress of the file operation and the “Memory used: nnn%” message changes to read “Loading ...” or “Saving ...” as the case may be. If you are loading a MIDI File, more time is taken up by processing than by actually reading the disk, so “Loading ...” alternates with “Processing ...” (during which time you won’t see any disk activity)—indeed, if you are lucky (rich?) enough to work from a hard disk you’ll see only the briefest flashes of “Loading ...”. When the file operation is complete, the memory display reverts to its normal state.

**A note of caution about changing disks:** On a single-drive system, if you want to load from, or save to, a different disk from the last one you used, **DO NOT** use the straight **Save** options. When the file selector appears, it is good practice to tell the operating system that you are changing disks. To do this, press  (which takes the text cursor onto the top line), then press  to clear the line. Next type : to change the disk drive name. If you have one of the more sophisticated versions of the file selector in an AUTO folder (there are various ones around), you may just be able to **Click** on one of the lettered buttons which represent disk drives—this makes it all a lot easier. Finally, **Click** on the grey bar immediately above the list of files. This forces the disk drive to re-read the directory. You’ll get an alert box telling you to insert Disk B in Drive A. Do this (if you haven’t already) and **Click** on OK.

Not doing the above can give rise to unpredictable, and sometimes disastrous, results (such as over-writing the directory of the disk you’ve just inserted with the directory of the one you took out, thus rendering all the files on the current disk inaccessible). Under certain circumstances, the sequence of events can lead to the poor computer trying to find a folder that isn’t there, and it will tell you so (see over page ...)



You can read about some of the quirks and oddities of MIDI Files (and other programs that use them!) in **Appendix D**.

**6**

- 6.2.4 **Delete file** is the usual utility for getting rid of rubbish from your disk—you might, for example, be rash enough not to want to keep backup files! It does ask you if you're sure before going ahead.
- 6.2.5 **Quit** drops you out of the program and back to the desktop, and of course you get that same warning in case you might have become temporarily unhinged.

## 6.3

This is a very short menu:

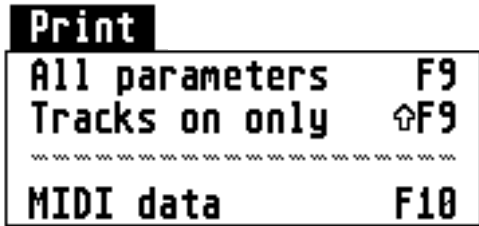

**6.3.1 All parameters** will print out, in a reasonably intelligible form, details of the parameters currently set for all 16 tracks. This includes the title of the whole work, the tempo and the title and on/off status of each track.

**6.3.2 Tracks on only** does the same, but just for those tracks currently turned on, allowing you to be more selective and waste less paper, ribbon, power, time, coffee, etc.

**6.3.3 MIDI data** lets you print out the MIDI data from a selected track. This is a relatively unusual, though simple and obvious, feature which allows you to keep hard copy of the event list (see page 63) for reference. See the next page for how to select the track whose event list you wish to print.

***NB** All three of these print options can be interrupted by means of the **UNDO** key (if you're quick enough), and all of them display this message before the printing begins:*



### 6.4 SELECTING TRACKS AND EDITING

The specific functions in the **Edit** menu require a whole chapter to themselves, so that will take up **Chapter 7**, but first, there are certain standard features that apply to all these functions, mainly to do with selecting the tracks to work on.

You will already have done this in the tutorial, but here it is again in more detail. When you select many of the options from the **Edit**, **Track** or **Other** menus, or **MIDI data** from the **Print** menu, the first thing you must do is select a *source* track (*ie*, the track from which you are reading data for some purpose). If the function you have chosen concerns MIDI data (*ie*, most of them), the program will check whether there is any MIDI data there, and if not you'll be told so—**Click** on OK or press  and the operation will be abandoned.

6











If data (parameters or MIDI data) is to be changed in any way, the result of your edit or copy will have to be put somewhere—a *destination* track. You can either put it back where it came from, replacing the previous data, or put it in another track. Before the edit goes ahead, you'll be asked to select this track in the same way. If you select a protected track, you won't be allowed to put it there and you'll be asked again. If you select a track that isn't protected but already contains some MIDI data, you'll be asked if you want to replace it. If you say no, you can select another track (or abort as before) ... this can go on for some time!

Each time you select a track, the mouse pointer becomes a pointing hand and you will see a box on the screen, asking you to select by ...

#### MOUSE

... **Clicking** in the title area of the track you want to select.

#### KEYBOARD

... using either set of number keys from  to  to select tracks 1 to 10 respectively;   main to   main or   num to   num select tracks 11 to 16.

The selected title area will be reversed. If your choice of function was a result of short-term mental ill-health, you can abort the operation by pressing —you see the alert box opposite.



If the function involves actually *changing* anything (an edit of some kind), the program checks—even before asking you to select a track—to see if all the tracks have been protected. If they have, it won't let you do anything at all—you'll have to unprotect a track first.

After any edit, *the parameters are always copied from the source track to the destination track* (with the same conditions as **Copy parameters**—see page 63). As with **Play**, they don't actually affect anything, but the relationship between the source and destination tracks is made clearer if the parameters are the same. Of course your judicious use of titles makes it clearer still.



6

In all the edit screens, there is a choice of OK or Undo buttons (with keyboard alternatives **RETURN** and **UNDO**) by which to leave that particular screen. In every case, OK means you have accepted the changes and takes you on to the next part of the process (if any), and Undo leaves the edit entirely and nothing is changed. In all the descriptions of editing and other functions (coming soon ...), “leave the screen” refers to these options. Some of the other screens (eg. **Passes** and **Event list**) have an EXIT button. This is the same as an OK button, but without the implication that you are accepting some kind of change—Undo would therefore be superfluous.

While the actual processing is going on, there is the famous Atari busy bee on the screen, and in most cases you can still abort the process (if you're quick enough) with **UNDO**.

**NB** Although all the tracks are monophonic when first **Fractated**, some of the editing functions (**Quantize**, **Other reflects**, **Rotate**) are very likely to result in a *polyphonic* track, so be sure you have your MIDI instrument(s) set up accordingly. Also, in all the MIDI editing functions, the original *lengths of notes* are unchanged, so when you (*eg*) quantize, the entire note is shifted each time, so that the *attack* is on the quantized value. This sometimes results in some very staccato effects.

Whenever you return to an edit screen you have already used, you will find the same values there that you last selected. The program always remembers these, and they are also saved in your .FM1 and .FM2 files.

6

One final general point about editing: all velocity values are preserved in the edited track. If the material was taken from a MIDI File and includes non-note data (see **Chapter 11**), **FRACTAL MUSIC**, which itself generates only note data, will use its discretion in treating this data in the most sensible way in the editing process.

## 6.5

This menu offers various utility functions.

### 6.5.1 Protect

You will have tried this already in the tutorial. If you have produced something you're really pleased with and want to ensure that you don't corrupt it, select this option, and select the track to protect in the normal way. The track number (far left) will then be reversed like this ...

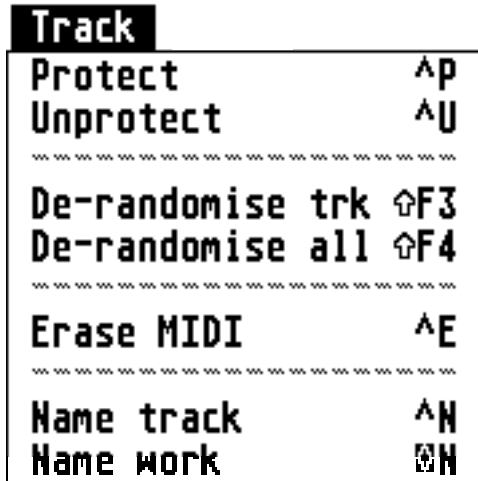

6

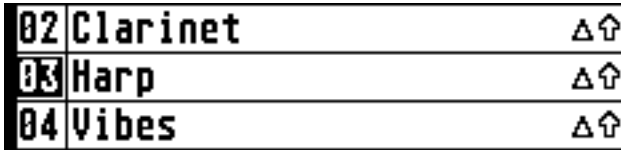

... and you won't be able to change or erase the MIDI data or parameters on that track (except on/off, MIDI channel and title) until you ...

### 6.5.2 Unprotect

This has the opposite effect. Suppose you've run out of tracks and want to do another edit: save to disk, then **Unprotect** a track in a similar way to **Protecting** it. The track number will return to normal display. You can then replace the tracks and use **Save as ...** to save a new file, and that way you've lost nothing.

### 6.5.3 De-randomise trk

Another one you've already done. If you have found some random parameters that have produced results you like, select this option, select the track as usual, and any random parameters on that track will retain their current value but be de-randomised and return to normal display. It also means that the same values will be copied after an edit or when you use **Copy parameters** (see the **Other** menu).

### 6.5.4 De-randomise all

This is even simpler: just select this option and *all* random parameters on *all* tracks will be de-randomised as above without your having to do anything else.

### 6.5.5 Erase MIDI

This is just what it says: select a track in the usual way, and the MIDI data on that track will be erased, leaving you an empty track to work on (the parameters will remain untouched). You'll be asked if you're sure before it goes ahead.

### 6.5.6 Name track

As you know from the tutorial, you can **B-click** in any track's title area to name a track. This menu/keyboard option automatically gives you the input window *for the track where the cursor-box currently is*. Your title can be up to 23 characters long, which may seem a bit of a peculiar number (prime, yet!), but we believe in letting you use all the available screen space, and that's how much happens to be available.

6

### 6.5.7 Name work

Exactly as above, but for the main title, which is limited to 16 characters. Notice that we don't call your pieces of music "songs" in this program—generally speaking, they'd be pretty hard to sing!

## 6.6

This menu offers some more general utility functions.

### 6.6.1 Copy parameters

Select a track to copy from, then a track to copy to, and hey presto! the parameters of the second track become the same as those of the first. Any randomised parameters will have *new random* values. The title, on/off status and MIDI channel, however, are *not* copied.

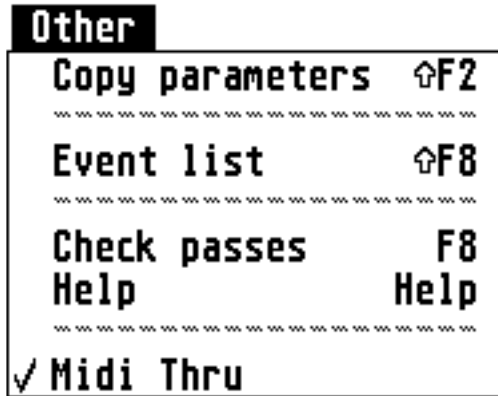

### 6.6.2 Event list

This is another feature that should be familiar to sequencer users, except that this one, so far, isn't editable. It is only intended for reference, but is nevertheless useful in helping you to decide what editing you want to do. Having selected it from the menu, you select a track in the same way as for editing, and you see something like the picture on the next page ...

0009.50	05	Note	♯	B 6	046
0009.53	05	Note		B 6	off
0009.61	05	Note		C 5	off
0009.63	05	Note	♯	A 2	043
0009.75	05	Note	♯	F# 2	090
0009.77	05	Note	♯	E 2	070
0009.91	05	Note		A 2	off
0009.91	05	Note	♯	C# 6	048
0009.91	05	Note	♯	D 4	030
0009.95	05	Note		D 4	off
0010.02	05	Note		C# 6	off
0010.02	05	Note		E 2	off
0010.04	05	Note		F# 2	off
0010.14	05	Note	♯	G 2	063
0010.19	05	Note		G 2	off
0010.41	05	Note	♯	A# 6	056
0010.44	05	Note	♯	C# 2	091
0010.51	05	Note		C# 2	off

TOP

PAGE ↑

½ PG ↑

½ PG ↓









PAGE ↓

BOTTOM

EXIT

This is part-way through a track, and shows, from left to right, the time, MIDI channel, type and values of each MIDI event in the track. To the right of these are the buttons for scrolling through the data. *Note:* up or down a “page” really moves you one line less than a page to give continuity (the last line of the previous page is the first of the new one, or vice versa).

KEYBOARD

-   Up, down a page
-     Up, down half a page
-  Top of list
-  Bottom of list

6.6.3 Check passes

This is useful if you have lost track of how many times you are going through each loop when **Fractating**, because you have to multiply all the values together to get the total (remember the default,  $3 \times 3 \times 3 \times 5 = 135$ ?). When you select this function, you see ...

<b>EXIT</b>	Lp	Lp	Lp	Inr	Total no.
	3	2	1	lp	of passes
Track 01	03	03	03	005	000000135
Track 02	03	03	03	005	000000135
Track 03	03	03	03	005	000000135
Track 04	03	03	03	005	000000135
Track 05	03	03	03	005	000000135
Track 06	04	02	03	006	000000144
Track 07	03	03	03	005	000000135
Track 08	03	03	03	005	000000135

... this is, in fact, just the left-hand half of the display. The other half looks the same, for tracks 9 to 16. The four loops are shown inside each other to make the setup clearer. The big box shows the result of multiplying the four numbers together. Notice that track 6 shows a different total because Loops 3 and 2's "how many" parameters and the Number of Inner Loops have been changed. It also shows the on/off status of each track.

6

When the "how many" parameters are big, not only does the total number of passes become difficult to work out, but you can produce an awful lot of music. Just for fun, we worked out the

maximum possible: if you set these "how many" parameters:

↑ 01 01 99 01 99 01 99 999 A

... you get *THIS TOTAL*:

↑ 99 99 99 999 969328701

If each of these 969,328,701 passes produced only *one tick's worth* of music, and was played at 120.00 bpm, it would last **8 weeks, 2 days, 10 hours, 23 minutes and about 7½ seconds** (just under 2 months). This is, however, entirely theoretical, and would depend on having an inconceivable amount of memory in your ST. In practice, using a 1040 with 1 small accessory loaded (but no RAM disk), the maximum number of passes allowed was about 50,000, which is a bit more realistic. On average, this will still give about 1 hour and 20 minutes' monophonic music at 120.00 bpm. All this applies to **Fractating one track only with nothing else so far recorded**. See **Chapter 10** for memory restrictions.

Leave the **Passes** screen the same way as the **Events** screen.

### 6.6.4 Help

6

Whichever stage of the program you are at, this option shows you a complete list of keyboard commands available at that particular point. In most of the edit functions, all the menu items are shadowed (*ie*, unavailable) *except* for all the **Desk** menu, **Quit** in the **File** menu, and **Help**. Depending on whether you are in the main screen, or one of the edit screens, the event list, or the keyboard input window (although the menus are inaccessible from the input window, you can still press ) you will be given different information—just that which is relevant at the moment.

Just as an example, here's the **Help** screen for **Invert** (coming soon ...):

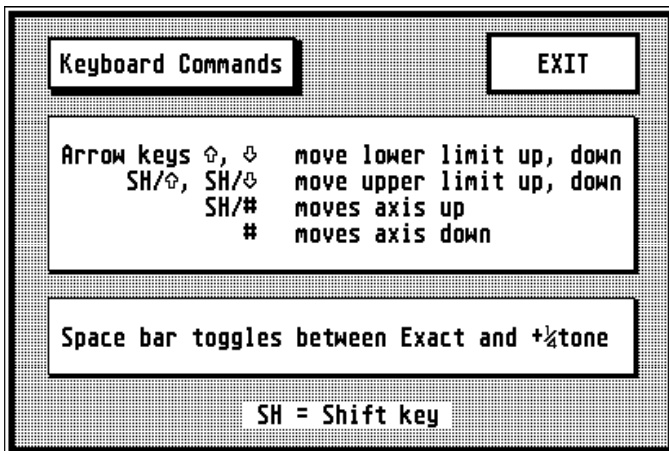

The **Help** screens vary in size, according to how much information is required.

For the main screen and the keyboard input window, there are two **Help** screens. On the first there are 2 buttons, EXIT and MORE. Clicking on MORE takes you to the second **Help** screen. This has the same two buttons, so you can switch between screens, or exit from either. There is no **Help** screen for **Check Passes**, because there are no keyboard commands (except the usual for leaving the routine).

A full list of keyboard commands is to be found in **Appendix B**.

### 6.6.5 MIDI Thru

When this is turned on (as it is by default), you can play your keyboard and **FRACTAL MUSIC** will re-route what you play to whichever MIDI channel you require. This is essential if you are using rack modules, drum machines, etc. which you control from a remote keyboard. If your keyboard is itself a sound-producing instrument (rather than just a controller), it should have a “Local Control Off” mode, which is the recommended way to operate when you are using **MIDI Thru** in a program such as this.

6

The output channel is determined by the position of the cursor-box: *ie* the data is sent out on the channel of the track where the cursor-box currently is. There are, therefore, two ways to change the output channel: *either* change the channel of the current track *or* move the cursor-box to a track which is already set to the channel you want.

There are certain times when your playing is cut off, such as during **Fractation** and **Playback** and one or two other time-critical operations (loading and saving, for example), but you can play “through” any of the editing screens, etc., though you won’t be able to change the channel at these times.

To turn **MIDI Thru** off (or on if it’s already off) merely select this menu item. If it’s on there will be a tick next to it in the menu (as shown here); if it’s off there won’t.



## CHAPTER 7

# THE EDIT MENU

### 7.1 QUANTIZE

This will be familiar to sequencer users.

Edit	Track	Other
Quantize		^Q
Stretch/Move		^S
.....		
Invert		^I
Retrograde		^R
Retro/Invert		⊞I
.....		
Other reflects		⊞O
Rotate		⊞R

You choose the *shortest* rhythmic value you want (eg semiquaver or 16th note) and each note in the track is shifted to the nearest position in time that fits the specification, whether that time is before or after the note in question. **FRACTAL MUSIC**'s **Quantize** function has a difference, though ...

Most sequencers will allow you to quantize only to a value which is an exact number of "ticks" (the shortest available time-value—**FRACTAL MUSIC** has a resolution of 96 ticks per crotchet, or quarter-note). In **FRACTAL MUSIC** you can also choose values that involve approximation, because at most tempi you can't hear the difference (which is never more than half a tick).

First things first, though. After successfully selecting your track, you will see this screen ...

... which is where you choose the mode for quantizing. **ABSOLUTE** is more or less self-explanatory; **RELATIVE** means your shortest value will be a fraction of a whole-note (or semibreve or 4/4 bar).

**Quantize Value**

**RELATIVE**  
(quavers, tuplets, etc)

**ABSOLUTE**  
(exact number of ticks)

Undo

OK

7

**MOUSE**

**Click** on the option you want.

Leave the screen.

If you select **RELATIVE**, you'll then see this ...

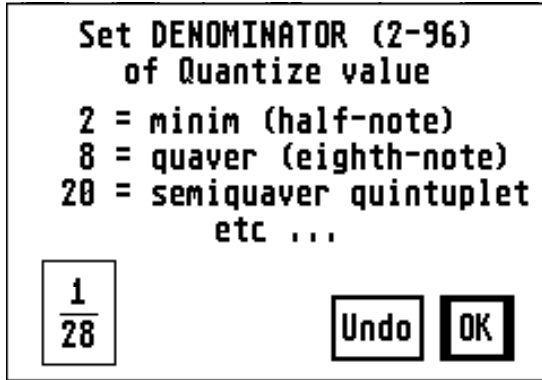

7

Use the same technique as on the main screen to change the value (where it says 28 in the picture).

**MOUSE**

**R-click** = up, **L-click** = down, different positions giving different increments.

**KEYBOARD**

num = up, num = down, with or without  for different increments.

num gives 2, num gives 96.

The example shown is an approximation, because  $38\frac{4}{28} = 13.714285$ , and you can't have .714285 ticks! In fact, it will produce a combination of time values of 13 and 14 ticks, but it'll certainly sound like semiquaver septuplets. When you've set the value, leave the screen.

If, on the other hand, you chose **ABSOLUTE** from the first box, you'll see this ...

Set **NUMBER OF TICKS (2-384)**  
for Quantize value

192 = minim (half-note)  
48 = quaver (eighth-note)  
16 = semiquaver triplet  
etc ...

... which is very similar, except that you are now choosing an *exact* number of ticks for your quantize value (yes, 109 is pretty obscure). Change the number in the box in the usual way, then leave the screen.

There will be a short delay while the program does some work (you'll see the "busy bee" for a while), and it's done.

7

## 7.2 STRETCH/MOVE

This is quite a powerful function. Taking the **Move** part first (because it's simpler), you can move the music (in visual terms) sideways or up or down—*ie* forwards in time (or backwards if it doesn't already start at 0000.00), or transposed up or down in pitch. Here's an example:

**MOVE ENTIRE RANGES:**  
Up or down (transpose)  
Left or right (time offset)

	Old		New
Notes:	F 6	Top	G# 6
	C 5	Bottom	D# 5
Events:	0000.00	First	0004.48
	0022.16	Last	0026.64

**EXPAND  
or  
COMPRESS  
as ratio of**

New:Old

0001:0001 Pitch

0001:0001 Time

Undo

OK



7



In the left-hand part of the display, the existing top and bottom notes, and first and last event times of the track, are shown under “Old”. There's nothing you can do to those values, but you can change the “New” values next to them. In this example, the music has been moved 4½ beats later and transposed up a minor third (3 semitones).

### MOUSE

The usual technique changes the values up or down.

### KEYBOARD

,  transposes by semitones; with  by octaves.

,  moves backwards or forwards by one tick; with  by one beat.

For obvious reasons, the New values change in pairs when you alter them.

You can also **Stretch** or **Squash** the music horizontally or vertically. Here's an example of that:

**MOVE ENTIRE RANGES:**  
Up or down (transpose)  
Left or right (time offset)

	Old		New
Notes:	F 6	Top	A 6
	C 5	Bottom	G 4
Events:	0000.00	First	0004.72
	0022.16	Last	0017.40

**EXPAND  
or  
COMPRESS**  
as ratio of

New:Old

0003:0002 Pitch

0004:0007 Time

Undo

OK

7

Here, the pitch range has been *widened* by a factor of 3:2, and the time scale has been *compressed* by a factor of 4:7 (thus speeding the music up to nearly twice its tempo). In this instance, the music has not really been *moved*, though that's not obvious because all the values in the "New" column have been changed by the stretching/squashing—you'll see that the difference between the old and new Top notes is approximately the same as that between the Bottom notes, and similarly the differences between the old and new first and last events. As far as possible, the program keeps the *centre point* of the range the same and "pushes out" or "pulls in" on either side of it.

**MOUSE**

The usual technique on any of the four values in the right-hand part of the display.

**KEYBOARD**

- num increases the pitch numerator (under "New").
- num increases the pitch denominator (under "Old").
- num increases the time numerator.

num increases the time denominator.

Any of these keys with  decreases the corresponding value.

This may seem like an arbitrary choice of keys, until you look at how they are arranged on the keyboard (anybody remember the *WordStar diamond*?—similar idea).

Naturally, there's nothing to stop you doing both operations in one go—for example, this one could be moved back to start at zero so that there's no delay when it is played back, and perhaps dropped an octave or two to suit a bass sound of some sort.

After all this, leave the screen.

This is one of the functions that can be used as a straight *Copy* facility (for MIDI data, that is). Make sure both the ratios on the right are 0001:0001 and that the new notes and event times are the same as the old, and nothing will change.

**NB** Unlike the main screen, and some of the other edits (coming right up), this function overrides any pitch range limits you may have set—it is up to you to see that the new top and bottom note values are suitable for your purpose.

How about loading PREL2.MID (which you should remember from the tutorial) and seeing how Bach sounds when his pitch range is stretched or squashed?

### 7.3 INVERT

This allows you to turn the music upside down, which composers have been doing for centuries. If, in your original track, a note is a minor 6th above the one before, after **Inversion** it will be a minor 6th below—*usually* (read on). To mathematicians, it is a reflection in a horizontal axis.

After selecting the track to invert, you will see something like this ...

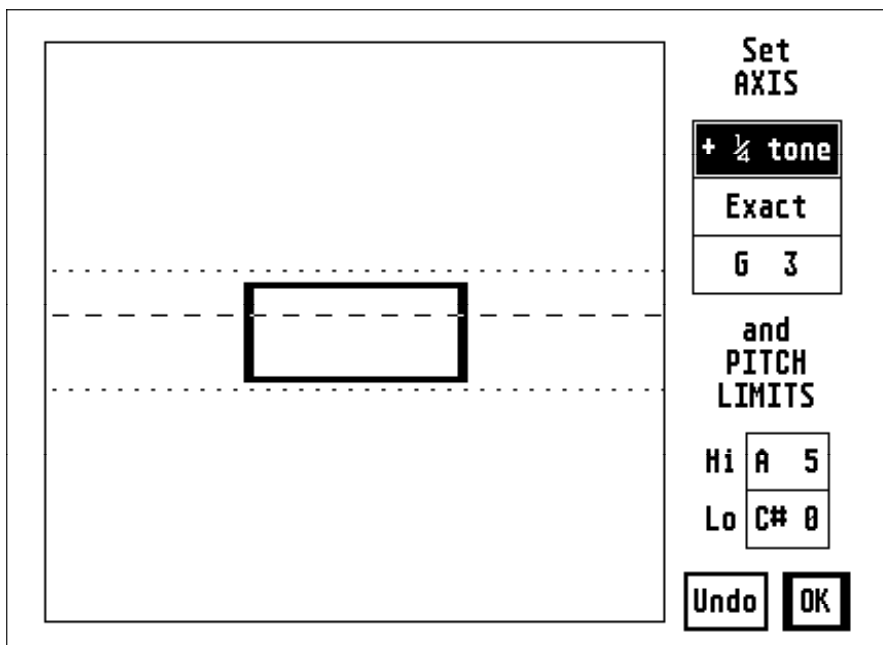

The heavy box in the middle is where your original track would “fit”: the width represents the duration of the whole track, and the height is the interval between the lowest and highest notes in the track. This is a medium-length track—for a shorter one, the box would be much squarer; for a longer one it would be longer and thinner. This box idea gets used again, so keep it in mind.

The **AXIS** you are asked for is the pitch value that the music will be reflected in, represented by the line of dashes. The **PITCH LIMITS** are represented by the dotted lines. To change any of these note values ...

MOUSE

Usual technique.



KEYBOARD

 ,  move the lower limit up/down.

  ,   move the upper limit.

  moves the axis up.

 moves the axis down.

In case you are unfamiliar with the ST keyboard,  is just below  (to the right of ).

The **AXIS** can also be exactly on a note or “between” notes. In this example a between-notes value has been chosen (between G3 and G#3), so that G3 will become G#3 and vice versa; similarly for F#3 and A3, F3 and A#3, and so on.

7

MOUSE

**Click** on the appropriate box.

KEYBOARD

 toggles between them.

Now what about that ominous *usually*? According to where you set the limits, the same “folding” rule applies as when **Fractating**, so sometimes parts of the track will be transposed, rather than inverted. This is because the music has been inverted about the **AXIS**, then inverted again about a **LIMIT**. You can see when this is going to happen by the spacing of the box and lines on this screen.

## 7.4 RETROGRADE

This is another thing that’s been going on for ages—turning the music backwards (reflection in a vertical axis). There are no axes, limits, etc. to set for this, so you just select the source and destination tracks and that’s it.

## 7.5 RETRO/INVERT

This is merely a short-cut combination of **Inversion** and **Retrograde**—another time-honoured technique. For this you set the **AXIS** and **LIMITS** just as for **Invert**, and the program does the rest.

## 7.6 OTHER REFLECTS AND ROTATE

Now we start getting a bit more *recherché*. Inversion, as we have seen, is really a reflection in a horizontal axis, retrograde is a reflection in a vertical axis, and retrograde-inversion is, in fact, a rotation through  $180^\circ$  (think about it ... or try doing it with some asymmetrical object—a floppy disk is ideal).

With **Other reflects** you can reflect your music *in an axis set at any angle* you choose, and with **Rotate** you can rotate your music *through any angle*, either of which can produce some very surprising results! OK, so you pre-empted the manual by seeing if **Retro/Invert** produces the same result as **Rotating** through  $180^\circ$ —and it didn't (quite). We'll own up: it's actually done a slightly different way, so it never comes out exactly the same (you must admit it's close, though—see *For the pedantic*, page 84).

We'll look at **Other reflects** and **Rotate** together, because the process of setting the parameters is much the same. After selecting your source and destination tracks, the first process you have to go through seems to be the same as for **Quantize**, except that you are asked for a “Scaling value” instead of a “Quantize value”. You do it exactly the same way (so see page 69 if you've forgotten how it goes), but why do you need to do it at all?

Unlike the other editing functions, when you **Reflect** or **Rotate**, both horizontal and vertical adjustments are made, so the program needs to know the proportions of one to the other. The scaling value, therefore, is the time ( $x$ ) value which will be taken as equivalent to 1 semitone—the smallest unit of pitch ( $y$ ). Confused? Suppose you've just created a tiny little track that's exactly 4 crotchets (quarter-notes) long, and has a range of a major third (4 semitones), say C3 to E3. If you choose a scaling value of  $1/4$  (or 96 ticks), then the length of your piece will be equivalent to 4 semitones, making a square box. If, on the other hand, you set the scaling to  $1/16$  (or 24 ticks, the default), it will be equivalent to 16 semitones in length, and be a long, low box ... get the idea?

Now where does that box come from when you set the axis and limits for **Invert**, if you don't set the scaling first? For that purpose,  $1/16$  is assumed simply in order to draw some kind of a box—the length of it is otherwise irrelevant (think about it).

7

Once you've set the scaling value, you will be presented with this picture:

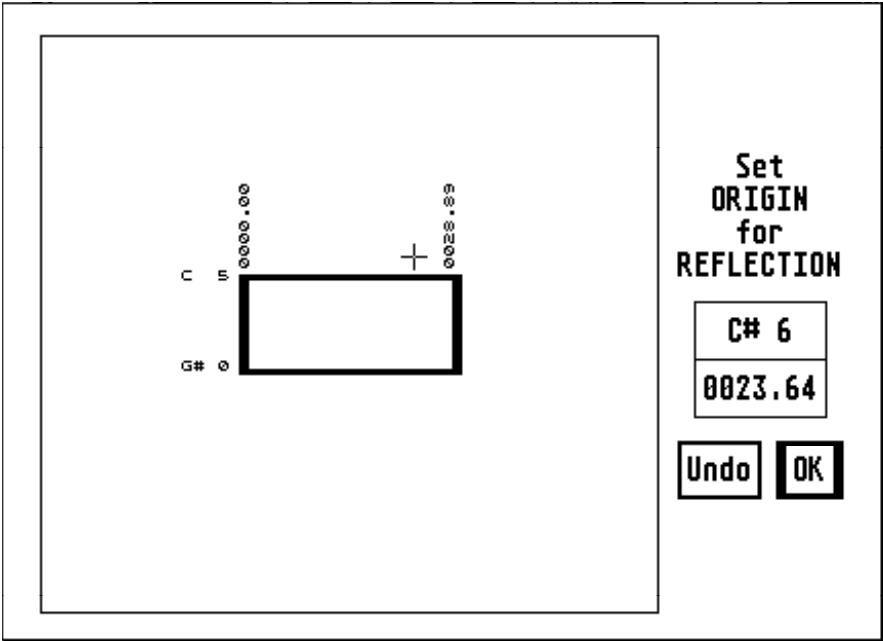

Yes, it says “Set ORIGIN for REFLECTION”, but if you had chosen **Rotate** from the menu it would say “Set ORIGIN for ROTATION”—in all other respects this particular process is identical.

What you are being asked to do is to set the Origin (*ie* the central point) through which your axis of reflection or rotation will pass. Notice that this time, the times and pitches of your original track are on the screen to help you.

**MOUSE**

You can set the origin in two different ways. For a fairly coarse setting, **Click anywhere inside the thin square**, and the cross-hairs will move to that point while the values in the boxes on the right change. You can also drag the cross-hairs around in the box by

**KEYBOARD**

(with and without **shift**) have the same effect as in **Stretch/Move**.

7

moving the mouse with a button *held down*, and you'll see the values on the right change as you do so.

To make a fine adjustment, you can change the values in the boxes on the right in the usual way.

The limits for this are determined only by the outer (thin) box—you don't have to stay inside the heavy box.

When you've set your origin, you'll see this ...

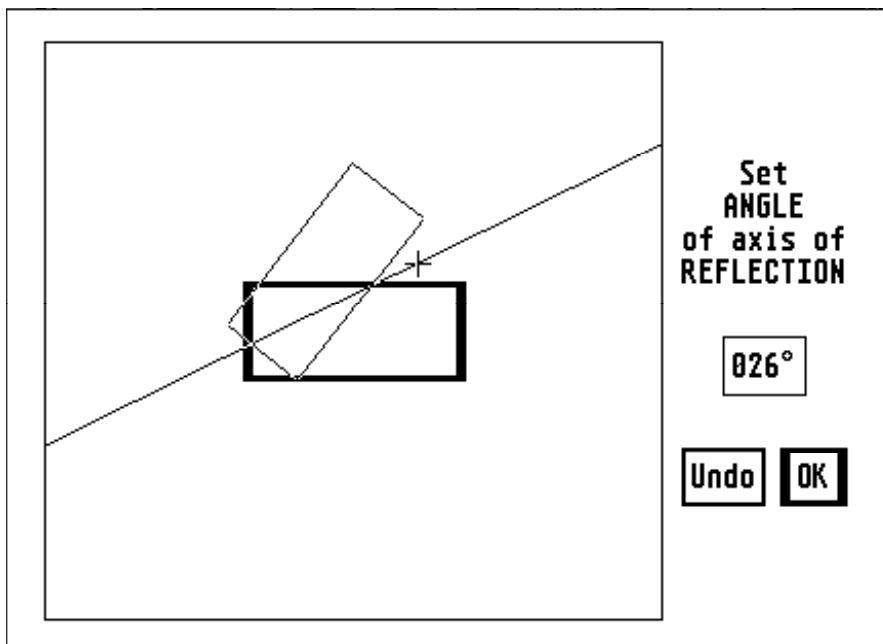

... if you're **Reflecting** ...

... or this ...

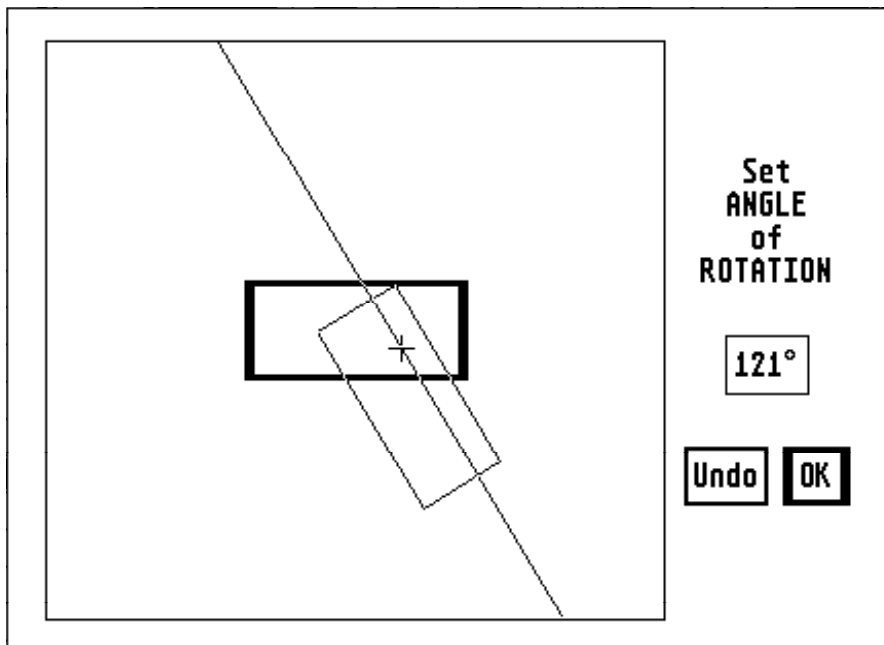

... if you're **Rotating**.

Actually, they won't quite look like these pictures at first, because here the angles have been set. You'll start from 000°, or whatever value was stored in your AUTOLOAD file. Note that the time and pitch values have now disappeared from the picture, as you no longer need them.

Both pictures are here because, although you set the angle the same way, the picture behaves differently according to what you are doing.

**MOUSE**

As with the origin, you can set the angle by using the mouse inside the big box, or by changing the value on the right—try it and see.

**KEYBOARD**

As in **Quantize** or the main parameter grid.

As you change the value, the axis moves round, and a thin version of the original heavy box is drawn either reflected in, or lined up with, the axis.

From here on, the pictures will follow a **Rotation**, though the procedure would be exactly the same for a **Reflection**.

The next thing you see is this ...

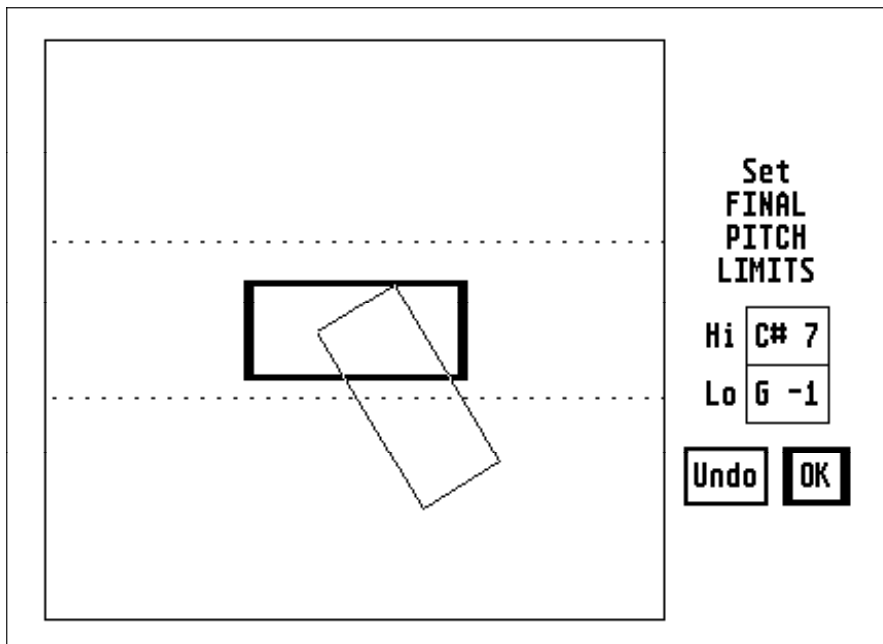

Now the cross-hairs and the axis have disappeared and you are being asked to set the pitch limits. You do this in just the same way as for **Invert**, but with no **AXIS** to worry about (you've already done that).

Once you've set the limits, if your new box goes outside them (which it may well), you'll be asked:

... if you say Yes you'll see the next picture (or something like it!) ...

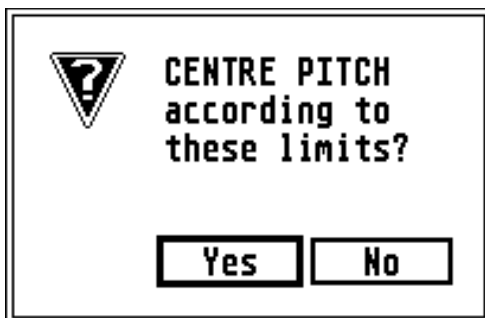

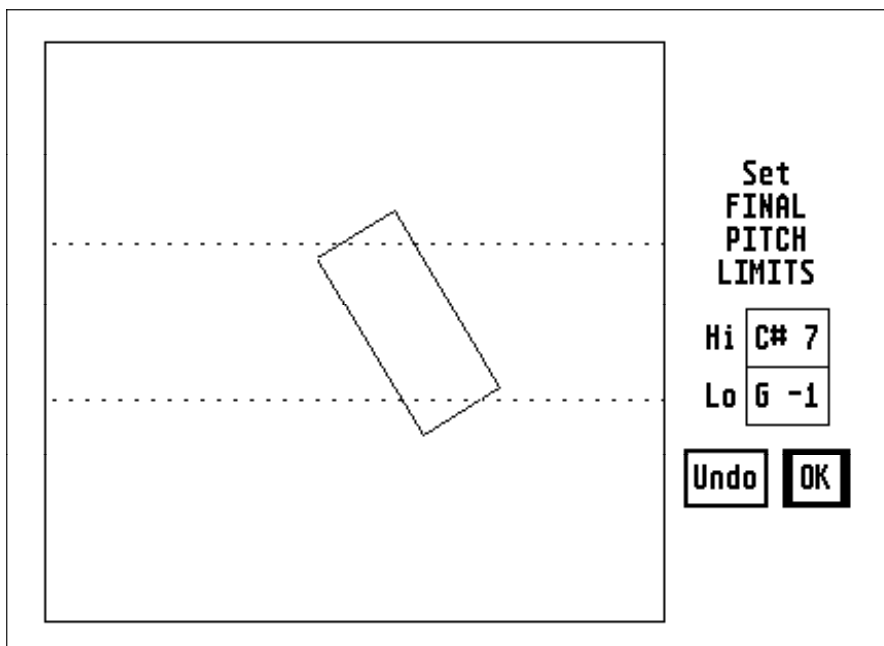

Note that now the original heavy box has gone, because you don't need that any more either. This is of course still outside the limits—if that is the case the music will be “folded” according to the usual rules, and just for fun you can see it on the screen. You will therefore be asked:

If you say No, you return to the main screen and the computer gets to work rotating or reflecting your material (remember you can still abort it with **UNDO** when the bee's on the screen).

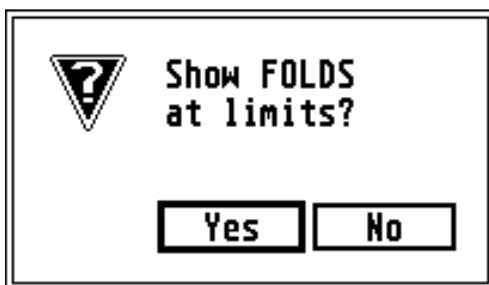

If, on the other hand you say Yes, here is what that particular rotation looks like if you *didn't* centre the pitches ...

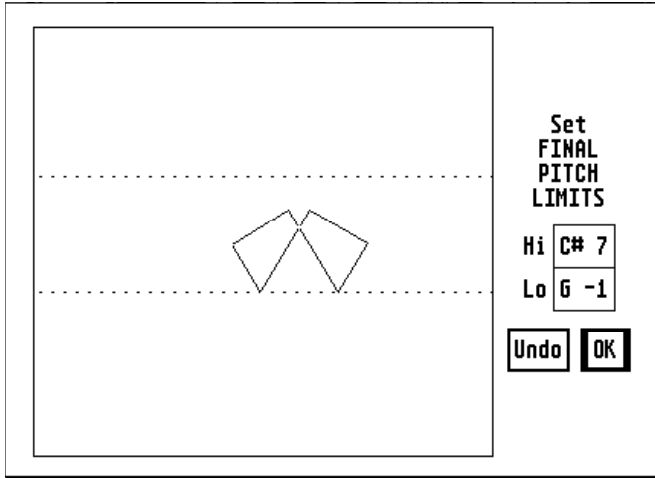

7

... and here is how it looks if you *did* ...

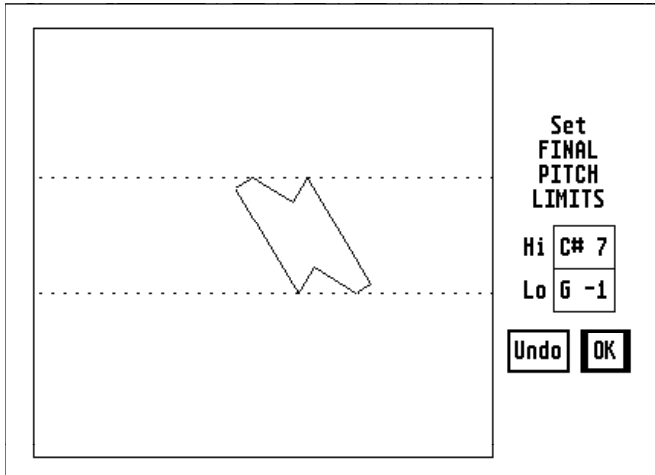

After each of these processes (centring and folding), leave the screen.

After all that, you'll no doubt listen to the result, and then go looking for a 12-bore and our address. It's all a matter of taste!

**For the pedantic:** If you consider a note to be a horizontal line from the note-on point to the note-off point, and rotate it through (say)  $24^\circ$ , the true result would be an upward glissando. Not only that, but the note values at the ends of this glissando would not necessarily be exactly on the notes in our normal scale (they would be some sort of microtones).

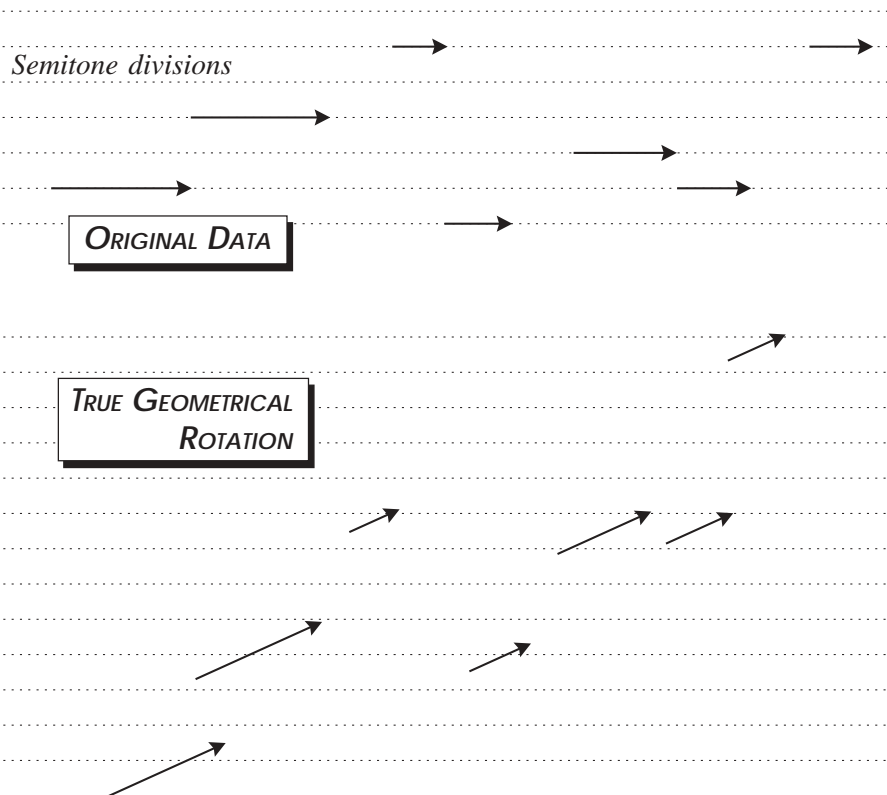

7

Well, if we had the famous 4X computer at IRCAM (Pierre Boulez's institute under the Pompidou centre in Paris) at our disposal, no doubt we could do all that. However, practical considerations come into play on this humble system (you'd need a separate MIDI channel and voice available for each individual note to avoid conflicts between the pitch-bend values), so what we do is rotate the starting point of that note and

place it on the nearest exact semitone. The sustained part of the note is “dragged round” with it as a horizontal line, leaving you with a note of exactly the same length.

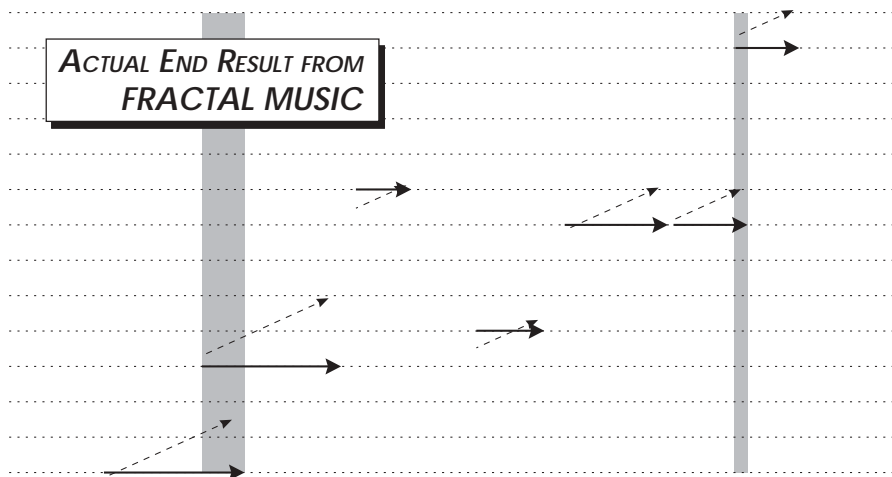







7





The two shaded areas show where pairs of notes now overlap—a polyphonic result from monophonic data.

The time element in all this is much more precise because we have much finer divisions (ticks) to play with. All this applies equally to **Reflection**.

**Rotate** is another function you can use for a straight MIDI copy: just rotate through 000° (with the origin anywhere you like), and make sure the pitch limits are outside the range of the original track, and nothing is changed. It’s less trouble, though, to use **Stretch/Move** for this.



Finally, you can use *all* the other keys on the keyboard to produce special characters if you want (remember that fancy title on page 33?—that was to show what can be done). Many programs allow use of the  key to get at special characters, but we let you use  too. This way (for those that know about this stuff) you can get most of the ASCII set—though there are still some characters you can't get. A full list of available characters is given in **Appendix C**, but a couple of especially handy ones are   $\circ$  which gives the  $^{\circ}$  symbol for degrees; and  gives a proper  $\frac{1}{4}$  symbol (unfortunately, the  $\frac{1}{2}$  symbol can't be had this way although there is one in the set). Don't worry about the printing routines—any character that can't be printed is changed to a dot.

The one to avoid (usually) is , as this is a special system command to give you a print-out of the whole screen. Don't panic too much if this starts happening (it takes a *l-o-n-g* time, and the whole picture probably won't fit across your paper anyway)—just press  again to stop it. If you did press those keys and *nothing* happened, it just means your printer wasn't connected or was switched off. Press the keys again, and you'll be back to normal.

## CHAPTER 9

# AUTOLOAD FILES

An AUTOLOAD file lets you use your favourite set of parameters automatically as soon as you load the program.

It is a standard .FM1 parameter file, but the program looks for one called AUTOLOAD.FM1 before it does anything else. It contains all the main screen parameters, titles and tempo—and more ...

As you may already have read in **Chapter 6.4** (or discovered for yourself), your values are retained between edits and saved in your files. For instance, suppose you quantized a track to 19 ticks in ABSOLUTE mode. Next time you call up **Quantize**, you'll find ABSOLUTE is still reversed (selected) and if you don't change this to RELATIVE, the value of 19 is still there in the second screen. This also applies to an AUTOLOAD file. If you have used the AUTOLOAD file supplied on your master disk, the first time you tried a **Rotation**, you will have found an angle of 15° already set. This is an entirely arbitrary angle, just to demonstrate that this happens.

**9**

The AUTOLOAD file supplied with the program has track 1 fully randomised—there are 8 randomisable parameters—so the values will be different each time you first **Fractate** after loading (although the values *will* be the same *before* you first **Fractate**), and a set of arbitrarily chosen edit values. You can change this at any time by saving your own AUTOLOAD file. One warning, though: if you try saving any type of file and call it AUTOLOAD, it will automatically be converted to .FM1.

Without an AUTOLOAD file, the program will set up all the default parameters, including edit values, on loading.

## CHAPTER 10

# MEMORY RESTRICTIONS

Most of the time you are using **FRACTAL MUSIC** you will be blissfully unaware of this, but whichever configuration of ST or STE you have (even a Mega 4), there are limits to the memory capacity. As you already know, the bar in the top left-hand corner of the main screen gradually fills up as you use up memory, and the line below the operating buttons tells you what percentage of the memory you have used at any point (these are updated every time the state of the memory has, or might have, changed). There are extra warnings when things are getting a bit dangerous. When you're above 90%, you see this message:



**10**

... and when you've used over 95%, you see this one:



In addition to this, whenever you are about to do anything that will (or might) fill up more memory (**Fractating**, loading a file or any of the edits), **FRACTAL MUSIC** checks first that you have enough memory (just as with disk space—see **Appendix E**). Normally, you see no sign of this, until one day you'll suddenly be told:

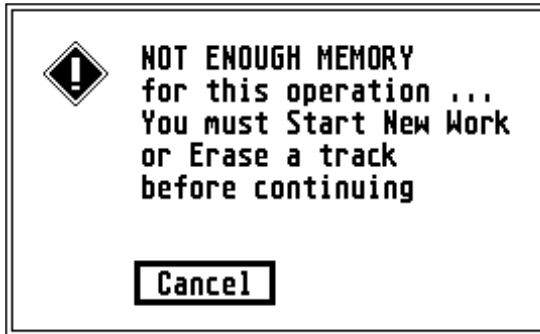

It's a bit alarming, granted, but it's preferable to losing all your work when the program crashes with an unhelpful "Out of memory" message at the bottom of the screen. This way, it stops you *before* that happens.

It is possible that you will see this message the very first time, after loading the program, that you try **Fractating** or loading a file. Maybe it happened when you were going through the tutorial, either at one of the editing stages or when you tried to load PREL2.MID. This must mean you are using a 512k machine, or have a large enough RAM disk installed to limit your memory to half a megabyte, or thereabouts, and you have too many desk accessories loaded. In that case, you must reduce the number/size of the accessories or remove the RAM disk. **Appendix E** explains how to do this. The tutorial was tested on a 1040ST with a half-MB RAM disk installed, along with one small accessory, and it all worked just fine.

This chapter should have made it clear why you won't be able to use the theoretical maximum number of passes (969,328,701—see page 65) for your **Fractation**.

## CHAPTER 11

# NON-NOTE DATA

This has been touched on briefly: there are many kinds of MIDI data apart from note-on and note-off, *eg* pitch-bend, program changes, modulation, other control changes, system exclusive data.

**FRACTAL MUSIC** itself generates only note-on/off data, but you might well have other data in your MIDI Files which you import from other programs. This is faithfully preserved by the program and, as far as possible, treated in a logical manner by the various editing processes—we cannot guarantee, however, that the occasional strange effect will not occur, in which case you may have to do some nifty event editing in your sequencer to avoid this (or restore it to something reasonable).

If in doubt, keep this kind of data in separate tracks in your sequencer and don't save it in your MIDI File for **FRACTAL MUSIC**.

## CHAPTER 12

# HINTS AND TIPS

This chapter contains a few ideas which have emerged from users of **FRACTAL MUSIC**.

It is not our intention here to tell you “how to compose” with the program, or even “how to get the best results”—that is for you to discover, and every user will find a different way to achieve the results he or she seeks. The suggestions which follow may help to point you in a new direction ... and anyway, we thought they were interesting. Our thanks to the people (named where possible) who have contributed them.

We won't be giving detailed explanations of how to carry out these suggestions, on the assumption that you have read the manual so far and will therefore know how to put them into practice.

### 12.1 MICROTONES

An Australian user, **Robert Martin**, has come up with a very simple way of making use of a *24-note scale* with **FRACTAL MUSIC**, assuming you have the necessary MIDI equipment.

You need either:

- ⊃ two MIDI instruments which can be set to different MIDI receive channels, and *one* of which can be de-tuned by a quarter-tone,

or:

- ⊃ a bi- or multi-timbral instrument on which it is possible to tune at least two simultaneous voices a quarter-tone apart—this is possible, for example, on the Yamaha DX11 keyboard (or its module equivalent, the TX81Z) as follows: set up a “Performance” with two voices set to different MIDI channels (possibly even using the same sound), and on only one of the voices set Micro-tuning ON and select “ $\frac{1}{4}$ -shift equal”.

In **FRACTAL MUSIC**, set up two tracks with identical parameters except that the **Versions** should be A and B respectively and the MIDI channels should be those you have just set up on your instrument(s). **Fractate** (if necessary, keep hitting  to re-start until you have a reasonably even distribution of notes between the two tracks), and you will have genuine 24-note music. See the explanation of **Version** (page 45) to clarify what is going on, and to see why we believe this has particular musical (and fractal) validity.

This could, of course, be extended to finer divisions of the scale by using more MIDI channels, but the theoretical validity of this would be more doubtful.

## 12.2 FRACTAL VARIATIONS

This idea, from **Roger Jeffs** in Norway, again relies on being able to use two or more MIDI channels, and works best where the variations between the timbres are quite subtle.

- 1 **Fractate** a track, using the first sound and restarting until you have something you like—preferably with reasonably flowing lines of notes.
- 2 If there are any random parameters, de-randomise them, then copy the parameters to another track, increase the number of inner loops slightly and **Fractate**, this time using the second sound.
- 3 Examine the two event lists, and adjust one or other of the two tracks with **Stretch/Move** in such a way that the first and last events of the two tracks coincide, then play them back together.

This process can be extended to as many tracks as you have sounds available (up to 16, of course) and can produce some wonderful textures. Try mixing the sounds so that the greater the number of iterations, the quieter the sound.

Different effects can be achieved by varying, in a similar way, the number of times **Loop 1, 2 or 3** is executed.

## 12.3 MORE VARIATIONS

Here is another way of using pairs (or more) of tracks with the same parameters but for one small change: set the starting value for **Loop 1, 2 or 3** to values which are different by one between the two tracks: the effects vary considerably depending on which **Loop** you choose.

## 12.4 UNFRACTAL MUSIC!

Set all three <sup>^</sup> **how many** values to 1 and the **Number of Inner loops** to a high value (even 999 is not too much). What results is a seemingly endless, meandering flow of music, without the fractal characteristic of self-similarity which this program usually produces.

Of course, you can do the same for the other loops—setting **Loop 3** to 99 and all the others to 1 gives a kind of ground bass which could underpin other variations.

## 12.5 PITCH EXPANSION *VERSUS* STRETCH/MOVE

Try this comparison: **Fractating** with different **Pitch Expansions** as against **Stretching** (and, if necessary, **Moving**) the music vertically.

## 12.6 PERFECT SYMMETRY

Play a track simultaneously with its **Retrograde** to produce a musical palindrome. You could move one of the tracks forward or backward in time to change the point of symmetry.

You've already tried vertically symmetrical music in the **Tutorial** (exercise 9), but how about original, **Retrograde**, **Inversion** and **Retro/Inversion** all together to square things up? You could also transpose the inverted track(s) to change the point of symmetry in the other dimension.

**APPENDIX A**

**PARAMETER REFERENCE GUIDE**

**MAIN SCREEN:**

<i>Name of Parameter</i>	<i>Low/High Limits</i>			<i>Default Setting</i>	<i>Random-izable</i>
Tempo	41.18	to	480.00	120.00	No
Track parameters					
MIDI channel	1	to	16	1	No
Loop 3	1	to	99	1	Yes
How many Loop 3s	1	to	99	3	No
Loop 2	1	to	99	1	Yes
How many Loop 2s	1	to	99	3	No
Loop 1	1	to	99	1	Yes
How many Loop 1s	1	to	99	3	No
How many Inner Loops	1	to	999	5	No
Version	A	to	C	A	Yes (A,B)
Lower pitch limit	C-2	to	Hi limit	A-1	No
Upper pitch limit	Lo limit	to	G8	C7	No
Starting pitch	Lo limit	to	Hi limit	C3	Yes
Pitch expansion	0	to	9	4	Yes (1–9)
Lower velocity limit	1	to	Hi limit	1	No
Upper velocity limit	Lo limit	to	127	127	No
Starting velocity	Lo limit	to	Hi limit	64	Yes
Velocity expansion	0	to	9	4	Yes

**EDIT PARAMETERS STORED IN FILES:**

<i>Name of Parameter</i>	<i>Low/High Limits</i>			<i>Default Setting</i>
Quantize				
Mode	Relative	to	Absolute	Relative
Relative value	2	to	96	16
Absolute value	2	to	384	24
Stretch/Move				
Pitch shift	N/A		N/A	0
Time shift	N/A		N/A	0
Pitch numerator	1	to	9999	1
Pitch denominator	1	to	9999	1
Time numerator	1	to	9999	1
Time denominator	1	to	9999	1
Invert				
Lower limit	C-2	to	Hi limit	A-1
Upper limit	Lo limit	to	G8	C7
Axis	Lo limit	to	Hi limit	C3
Fraction	Exact	to	+ ¼ tone	Exact
Other Reflects				
Scaling mode	Relative	to	Absolute	Relative
Relative value	2	to	96	16
Absolute value	2	to	384	24
Origin pitch	N/A		N/A	C3
Origin time	N/A		N/A	0000.00
Angle of axis	0	to	179	0
Low pitch limit	C-2	to	Hi limit	A-1
High pitch limit	Lo limit	to	G8	C7
Rotate				
Scaling mode	Relative	to	Absolute	Relative
Relative value	2	to	96	16
Absolute value	2	to	384	24
Origin pitch	N/A		N/A	C3
Origin time	N/A		N/A	0000.00
Angle	0	to	359	0
Low pitch limit	C-2	to	Hi limit	A-1
High pitch limit	Lo limit	to	G8	C7































APPENDIX B

**B**

**KEYBOARD COMMANDS**

num: Numeric keypad                      main: Main keyboard

**MAIN SCREEN:**

<i>Key</i>	<i>Purpose</i>	<i>Mouse equivalent</i>						
 	Fractate	<i>Click</i> on <b>Fractal</b> button						
	Play	<i>Click</i> on <b>Play</b> button						
 main	Increment tempo	<i>R-click</i> on units						
 main	Decrement tempo	<i>L-click</i> on units						
  main	Coarse increment tempo	<i>R-click</i> tens/hundreds						
  main	Coarse decrement tempo	<i>L-click</i> tens/hundreds						
  main	Fine increment tempo	<i>R-click</i> on decimal						
  main	Fine decrement tempo	<i>L-click</i> on decimal						
	Move cursor-box left	none						
	Move cursor-box right	none						
	Move cursor-box up	none						
	Move cursor-box down	none						
 num	Fine increment	<i>R-click</i>						
 num	Fine decrement	<i>L-click</i>						
  num	Coarse increment	<i>R-click</i> on tens/octaves						
  num	Coarse decrement	<i>L-click</i> on tens/octaves						
 num	Gives minimum value	none						
 num	Gives maximum value	none						
 num	<table border="0" style="display: inline-table; vertical-align: middle;"> <tr> <td style="font-size: 3em; vertical-align: middle;">}</td> <td>Randomises (some paras)</td> </tr> <tr> <td style="font-size: 3em; vertical-align: middle;">}</td> <td>Resets MIDI channel</td> </tr> <tr> <td style="font-size: 3em; vertical-align: middle;">}</td> <td>Solos track</td> </tr> </table>	}	Randomises (some paras)	}	Resets MIDI channel	}	Solos track	<i>B-click</i>
}	Randomises (some paras)							
}	Resets MIDI channel							
}	Solos track							
 	Main title	<i>B-click/Track</i> menu						
 	Track (with cursor-box) title	<i>B-click/Track</i> menu						

## MAIN SCREEN (CONTINUED):

	Start new work	<b>File</b> menu
	Load parameters	<b>File</b> menu
	Load all	<b>File</b> menu
	Load MIDI File	<b>File</b> menu
	Save parameters	<b>File</b> menu
	Save all	<b>File</b> menu
	Save MIDI File	<b>File</b> menu
	Check passes	<b>Other</b> menu
	Print all parameters	<b>Print</b> menu
	Print MIDI data	<b>Print</b> menu
	Delete file	<b>File</b> menu
	Copy parameters	<b>Other</b> menu
	De-randomise track	<b>Track</b> menu
	De-randomise all	<b>Track</b> menu
	Save parameters as ...	<b>File</b> menu
	Save all as ...	<b>File</b> menu
	Save MIDI as ...	<b>File</b> menu
	Event list	<b>Other</b> menu
	Print tracks on only (paras)	<b>Print</b> menu
	Quit	<b>File</b> menu
	Quantize	<b>Edit</b> menu
	Stretch/Move	<b>Edit</b> menu
	Invert	<b>Edit</b> menu
	Retrograde	<b>Edit</b> menu
	Retrograde/Inversion	<b>Edit</b> menu
	Other reflects	<b>Edit</b> menu
	Rotate	<b>Edit</b> menu
	Protect track	<b>Track</b> menu
	Unprotect track	<b>Track</b> menu
	Erase MIDI data	<b>Track</b> menu
	Display help screen(s)	<b>Other</b> menu

## FRACTATING:

	Stop/keep	none
	Stop/not keep	none
	Abandon/Re-start	none
	Pause (leave notes on)	none
	Pause (take notes off)	none

**B**

## PLAYBACK:

	Stop	none
	Re-start	none
	Pause (leave notes on)	none
	Pause (take notes off)	none

## FRACTATE/PLAY (IN PAUSE):

	Continue	none
--	----------	------

## SELECTING TRACKS (FOR EDITS, ETC.):

	main/num	Tracks 1–10	<i>Click</i> in title area
	main	Tracks 11–16	<i>Click</i> in title area
	num	Tracks 11–16	<i>Click</i> in title area

## QUANTIZE/SCALING FOR REFLECTION, ROTATION:















### MODE SCREEN

	Toggles relative / absolute	<i>Click</i> in box
--	-----------------------------	---------------------





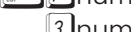

### VALUE SCREENS

	Small increment	<i>R-click</i>
	Small decrement	<i>L-click</i>
	Large increment	<i>R-click</i> on tens
	Large decrement	<i>L-click</i> on tens
	Minimum value	none
	Maximum value	none

## STRETCH/MOVE:

	Transpose up semitone	<i>R-click</i> on note name
	Transpose down semitone	<i>L-click</i> on note name
	Transpose up octave	<i>R-click</i> on octave
	Transpose down octave	<i>L-click</i> on octave
	Move back 1 tick	<i>L-click</i> on ticks
	Move forwards 1 tick	<i>R-click</i> on ticks
	Move back 1 beat	<i>L-click</i> on beats
	Move forwards 1 beat	<i>R-click</i> on beats
	Increment pitch numerator	<i>R-click</i> on value
	Decrement pitch numerator	<i>L-click</i> on value
	Increment pitch denominator	<i>R-click</i> on value
	Decrement pitch denominator	<i>L-click</i> on value
	Increment time numerator	<i>R-click</i> on value
	Decrement time numerator	<i>L-click</i> on value
	Increment time denominator	<i>R-click</i> on value
	Decrement time denominator	<i>L-click</i> on value

## INVERT:

	Moves lower limit up	<i>R-click</i> on value
	Moves lower limit down	<i>L-click</i> on value
	Moves upper limit up	<i>R-click</i> on value
	Moves upper limit down	<i>L-click</i> on value
	Moves axis up	<i>R-click</i> on value
	Moves axis down	<i>L-click</i> on value
	Toggles Exact / + $\frac{1}{4}$ tone	<i>Click</i> in box

### OTHER REFLECTS/ROTATE (SEE QUANTIZE FOR SCALING):

#### ORIGIN

(with and without ): see STRETCH/MOVE

**B**

#### ANGLE

, , , , , , , : see QUANTIZE (value screens)

#### LIMITS

(with and without ): see INVERT

### EVENT LIST:

	Moves to top of list	<i>Click</i> on TOP
	One page up	<i>Click</i> on PAGE UP
	Half page up	<i>Click</i> on ½ PAGE UP
	Half page down	<i>Click</i> on ½ PAGE DOWN
	One page down	<i>Click</i> on PAGE DOWN
	Moves to bottom of list	<i>Click</i> on BOTTOM

### ALL SCREENS EXCEPT MAIN:

	Leaves screen (and executes)	<i>Click</i> on OK or EXIT
	Abandons operation	<i>Click</i> on Undo

### DURING PROCESSING OR PRINTING (DISPLAYING BEE):

	Abandons operation	none
--	--------------------	------

## APPENDIX C













# EXTENDED ON-SCREEN CHARACTER SET



C















## FOR KEYBOARD INPUT ROUTINE

A list of all the possible characters available for titling your work and tracks in **FRACTAL MUSIC**. Those which can't normally be handled by printers are replaced by a . in the print functions.

The following keys have specific functions in the input routine, and are therefore not listed in the tables which follow:

	clears input line
	deletes backwards
	deletes forwards
	exits from routine, keeps changes
	as 
	exits from routine without changes
	displays Help screen
   	cursor movement

Where a blank appears in the tables, that key combination has either the same effect as one of the above, or no effect at all. In most cases these combinations are to be avoided—eg   will start a (probably unwanted) print-out of the screen. The following combinations are listed with the effect they produce:

 	
 	
 	
  num	
 	Print screen

The exception to this, unsurprisingly, is the set of combinations with —only  gives anything other than a space.

ALPHABETICAL KEYS:

Key	Char	Sh	Ctrl	Alt
A	a	À	↑	ß
B	b	Â	↓	â
C	c	Ç	↔	«
D	d	Ð	↔	á
E	e	È	⌘	É
F	f	Ê	⌘	í
G	g	Ë	⌘	ó
H	h	Ï		ú
I	i	Î	⊙	ù
J	j	Ï	⌘	ñ
K	k	Ë	⌘	ñ
L	l	Ë	⌘	à
M	m	Ë	⌘	ø

Key	Char	Sh	Ctrl	Alt
N	n	Ñ	/	ö
O	o	Ó	/	ü
P	p	Ô	/	ö
Q	q	Õ	/	É
R	r	Ö	/	ô
S	s	Ø	/	f
T	t	Ù	/	ö
U	u	Ú	/	û
V	v	Û	/	»
W	w	Ü	/	æ
X	x	Ý	/	i
Y	y	ÿ	/	ò
Z	z	ÿ	/	¼



NUMBER KEYS (MAIN KEYBOARD):

Key	Char	Sh	Ctrl	Alt
1	1	!	!	°
2	2	"	â	•
3	3	£	£	•
4	4	\$	\$	√
5	5	%	%	n
6	6	^	^	2
7	7	&	&	3
8	8	*	*	-
9	9	(	(	Ç
0	0	)	)	ü

PUNCTUATION/MATHS OPERATORS:

Key	Char	Sh	Ctrl	Alt
-	-	-	⌘	é
=	=	+	⌘	â
\	\	-	⌘	\
[	[	{	⌘	[
]	]	}	⌘	]
;	;	:	⌘	;
'	'	@	⌘	'
#	#	~	⌘	#
,	,	<	⌘	,
.	.	>	⌘	.
/	/	?	⌘	/
\	\		⌘	\

*NUMERIC KEYPAD:*

Key	Char	Sh	Ctrl	Alt
1	1	1	1	1
2	2	2	€	2
3	3	3	3	3
4	4	4	¥	4
5	5	5	§	5
6	6	6	×	6
7	7	7	7	7
8	8	8	8	8
9	9	9	9	9
0	0	0	0	0
(	(	(	✓	(
)	)	)	⊖	)
/	/	/	↖	/
*	*	*	↑	*
-	-	-	⌘	-
+	+	+	♪	+
.	.	.	↗	.

*FUNCTION/UTILITY KEYS:*

Key	Char	Sh	Ctrl	Alt
F1	†	†	†	†
F2	¶	¶	¶	¶
F3	Ⓒ	Ⓒ	Ⓒ	Ⓒ
F4	Ⓓ	Ⓓ	Ⓓ	Ⓓ
F5	™	™	™	™
F6	ij	ij	ij	ij
F7	ij	ij	ij	ij
F8	×	×	×	×
F9	1	1	1	1
F10	§	§	§	§
Tab	Ⓢ	Ⓢ	Ⓢ	Ⓢ
Space			..	
Ins	Ⓜ	Ⓜ	Ⓜ	
Clr	1	7	≈	



This is not the complete Atari character set. There are 65 more characters inaccessible directly from the keyboard. The table over the page shows these remaining characters for reference, with their ASCII codes.

Ç	13	ì	141	Ë	183	Ð	208	Θ	233
È	27	ñ	142	Ë	184	Ï	209	Ω	234
Δ	127	Ñ	143	´	186	Ƴ	211	δ	235
ü	129	ç	155	Ƨ	197	Λ	222	φ	236
ä	132	Ƴ	157	π	198	∞	223	Φ	237
à	133	ø	167	ı	200	α	224	Π	239
ã	134	ı	168	Π	201	Γ	226	≡	240
ç	135	Ƨ	170	U	202	π	227	±	241
ê	136	½	171	´	203	Σ	228	≥	242
ë	137	ø	179	Ƨ	204	σ	229	≤	243
è	138	œ	180	Ƨ	205	μ	230	ƒ	244
ÿ	139	Œ	181	ñ	206	τ	231	J	245
î	140	Ë	182	J	207	Ö	232	÷	246



## APPENDIX D

# ABOUT MIDI FILES

Just as ASCII or “plain text” files allow text to be transferred between different text-processing programs, the MIDI File standard is a means of transferring MIDI data between different MIDI programs, especially sequencers—and, disk formats allowing, between different computers. Most MIDI programs, including **FRACTAL MUSIC**, have their own special file formats, because each has its own data structure—in fact we don’t know of any programs which use *only* MIDI File for storing their data (this doesn’t mean there *aren’t* any—we just haven’t seen them).

**D**

When using any of these programs, if there is no need to transfer data to another program it is always more efficient to use the program’s own file format (.FM1 or .FM2 for **FRACTAL MUSIC**). It is usually faster, and retains a lot more information specific to that program. A MIDI File stores the bare minimum of information: the MIDI data itself and some of what are known as “meta-events”, *eg* titles, tempi, time signatures, etc.

There are three different file formats for MIDI File, numbered 0, 1 and 2. **FRACTAL MUSIC** does not recognise format 2, and won’t load it if it finds it (in fact, as far as we know, very few—if any—programs support format 2), so we don’t need to go into that. Format 0 holds all the information in one long track, with one title. Format 1 (generally the most useful) holds the information in a series of tracks, like most sequencers and **FRACTAL MUSIC**, with a first track for meta-events only (usually—read on) and the MIDI data in subsequent tracks.

When **FRACTAL MUSIC** saves a MIDI File, it is *always* format 1, even if you only save one track of MIDI data. That way, you get the title of the work and the tempo in the first track, and as many of your recorded tracks as you want (with their titles) following. You can be selective, because the program will save *only those tracks that are turned on*. Remember, though, it is only MIDI data—you won’t preserve any of your **FRACTAL MUSIC** *parameters* this way.

When loading a MIDI File, **FRACTAL MUSIC** will accept formats 0 and 1. Format 0 will give you *one* track of MIDI data, a main title (but no track titles) and a tempo. Format 1 gives you a main title, tempo, and up to 16 tracks of MIDI data, with track titles. If there are more than 16 tracks of MIDI data in the file (most sequencers have far more than 16 tracks, *eg* 60, 64, 99 and so on), **FRACTAL MUSIC** will load the *first 16*, then stop loading—you will get a warning about this.

One bit of information stored in a MIDI File is the “tick resolution” (see **Glossary**). **FRACTAL MUSIC**’s tick resolution is 96 per beat, and if it finds a different resolution in the file it adjusts all time values accordingly.

Most sequencers offer their own different ranges of tempi: if **FRACTAL MUSIC** finds a tempo that doesn’t exactly match one of its own tempi, it tweaks it to the nearest available one—any differences are likely to be negligible.

Loading and saving MIDI Files in **FRACTAL MUSIC** is a slower process than using the program’s own file formats, because the data has to be converted to a different form as it goes, so there’s quite a bit of processing going on. The various alert boxes, and the actual processes of loading and saving files are covered in **Chapter 6**.

When a note ends, this data can be stored as two different types of MIDI data. It can be a “note-off” event with any velocity from 0 to 127, or it can be a “note-on” with a velocity of 0. Only a very few (expensive) MIDI instruments recognise note-off velocity—most simply stop the note sounding (or rather, for those that understand all this stuff, go into the “release” phase of the note’s envelope). For this reason, and to make editing, etc. simpler and quicker, when a MIDI File is loaded into **FRACTAL MUSIC**, any “note-off” events are automatically converted to “note-on” events with velocity 0.

### QUIRKS AND ODDITIES

The above is all based upon the assumption that the MIDI File standard really *is* a standard, and is treated in a standard way by all software that uses it. Unfortunately, since **FRACTAL MUSIC** was first released (version 2.21) and this Appendix was first written, it has become increasingly apparent that this is not the case. The MIDI File handling routines in **FRACTAL MUSIC** have been altered a number of times since then—some of these alterations were, of

course, to fix bugs and improve performance, but many were to cater for the peculiarities described below.

**Titles** In the MIDI File standard, there is a meta-event for titles. There is also a meta-event for “any text” which, for reasons best known to themselves, the writers of some software (including C-Lab and Steinberg) use for titles. This meant that *Creator/Notator* and *Cubase* users could not transfer titles in either direction, until we arranged, in typical “belt-and-braces” fashion, for **FRACTAL MUSIC** to use *both* these events when reading and writing MIDI Files. In case you’re wondering, when **FRACTAL MUSIC** loads a MIDI File created in **FRACTAL MUSIC**, it will read the title one way, then immediately re-read the identical title in the other form and replace it—no problem!

When a format 0 MIDI File is loaded there is only one track, so there can be only one title. This will be assumed to be the title of Track 1, whether it originated as a main title or as a track title.



If **FRACTAL MUSIC** does not encounter a main title in the MIDI File (neither *Creator/Notator* nor *Cubase* seems to provide one), the default “Untitled” will be used.

When *Creator/Notator* encounters a main title, it creates an empty first track with this title, and all the music tracks are shifted down one. If you want to avoid this, make sure your main title in **FRACTAL MUSIC** is “Untitled”: in this case *no* main title will be included in the file. Although *Cubase* does not share this oddity of behaviour, it also doesn’t use a main title, so you may as well save a few bytes in file size if you’re a *Cubase* user. Programs that do use a main title (*eg SMPTEtrack*) will, in most cases, display it as an empty box after reading this file.

**Time Signatures** Although, strictly speaking, irrelevant to the way **FRACTAL MUSIC** works, this has been incorporated into its MIDI File routines. There are two reasons for this, the main one being that we felt it would be a courtesy to preserve a time signature you may have used in another program, so that if you save your music in (say) 5/8 in your sequencer, it will still be in 5/8 after “passing through” **FRACTAL MUSIC** for processing. The other reason? *Cubase* will not read a tempo unless there’s a time signature with it! If you are saving an original

**FRACTAL MUSIC** MIDI File for export (*ie* not after importing), the obvious default of 4/4 is written into the file.

**NB FRACTAL MUSIC** will read (and preserve) only the *initial* tempo and time signature it finds in a MIDI File—any subsequent changes to either of these will be discarded.

**Very High Notes From Nowhere** This one is strictly for *Notator* users. While testing our MIDI File routines, we discovered a curious quirk which arises if you create rests in *Notator* in a particular way. It is possible in the notation screen to input a note, then highlight it and press   to convert it to a rest of the same length. In fact, *Notator* transposes this note to a G8 (the highest note available to MIDI, which they assume no-one is likely to use, being 1½ octaves above the top of a grand piano). Naturally it is filtered out when *Notator* plays back, but unfortunately it is *not* filtered out when saved to a MIDI File. It will therefore turn up when loaded into another program (including **FRACTAL MUSIC**, *Cubase* and *SMPTetrack*). In practice, you are likely to hear a G7 or G6 (which is even worse), depending on your synthesizer's capabilities—but you *will* hear it ... beware!

**Roland SysEx in Cubase 3.0** For those *Cubase* users who still have this version, there is a bug whereby it writes Roland System Exclusive messages incorrectly in MIDI Files. **FRACTAL MUSIC** compensates for this, with the result that it will read a *Cubase 3.0* MIDI File better than *Cubase 3.0* if it includes this type of data!

**Format 1 First Track** Although, as described above, this track does not usually contain any music, this *is* only a convention and we found it necessary to adapt in order to cater for programs which do not adhere to it—in such a case you will be told that you are loading a MIDI File created in a “naughty” program, and any title found in this top track will be used as the title for Track 1, with no main title.

This also why, for technical reasons, if there are more than 16 tracks in the MIDI File you are loading, you are warned of this fact only when **FRACTAL MUSIC** reaches that point in the loading process, not when loading begins.

## APPENDIX E

# TROUBLESHOOTING

The time when you are most in danger of running into problems is when starting up, so before we list a few other potential problems and their solutions, we'll look at a "worst case scenario" for loading the program.

**E**

To begin with, if you have too many accessories or too large a RAM disk installed, the program will, in fact, crash before it's fully loaded! You will see "Out of memory" at the bottom of the screen. Don't panic—just press the reset button, do whatever you need to in the way of removing accessories, etc., reset again (or, if you've removed a reset-proof RAM disk, switch off, wait a few seconds and switch on) and reload the program.

Now you have enough memory, we'll imagine you've left FRACMUS.RSC out of the appropriate directory—you'll see a message to that effect. **Click** on "Quit" (or press ) and you're back to the desktop once again. Copy the resource file into the right directory and try again.

This time, we find that you are using a colour monitor and you've done a "Save Desktop" in low resolution. Here is what you'll see:

**Click** on "Oops!" (or press ) and you return to the desktop—all being well, for the last time! Go to the "Options" menu, select "Set Preferences" and **Click** on "Medium Resolution". When the computer has re-booted, do a "Save Desktop" to avoid the same happening again, and reload the program.

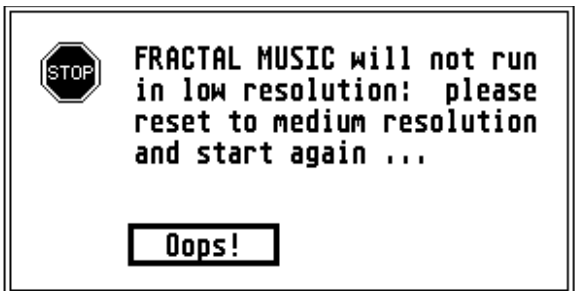

This all sounds very alarming but it need only ever happen once, if at all. If you copy the master disk exactly and use that copy, you should be straight into the program ...

Below are some difficulties you might run into during the running of the program (but we hope not):

<i>Possible problem ...</i>	<i>... and how to fix it</i>
I saved an AUTOLOAD file, but it doesn't seem to have loaded when I started the program.	You probably saved it in a folder. Quit the program and copy the AUTOLOAD file into the root directory—or wherever you have put your two FRACMUS files.
I seem to be getting a very jerky and uneven playback of data I imported from a MIDI File.	Check the <b>Event list</b> : you'll probably find a mass of non-note data there (most likely pitch bend or channel pressure). Although we have improved the playback routine since the earlier versions, this will inevitably clog up the processing. Try using the input filter in your sequencer to avoid piling up stuff that you and <b>FRACTAL MUSIC</b> don't want.
When I selected <b>Invert</b> , I didn't see both limits and the axis on the screen.	It was probably a short track with a narrow pitch range, so the picture you got was as if "zoomed in". Don't worry—it's all there, but off the screen. You can still adjust the note names in the boxes.
I don't always seem to get a response from my mouse clicks.	Atari mice and STs can vary in this respect. Try holding the button down fractionally longer.
I played back a track and there seemed to be a long delay before anything happened.	This is because the first event on the track is not at 0000.00. There may have been a similar delay when you

**E**

	<p><b>Fractated</b> or, more likely, you have squashed (horizontally), rotated or reflected the track, which has pulled the ends inwards, thus moving the first event considerably later. If in doubt, have a look at the <b>Event list</b> to see exactly when the first event should happen.</p>
<p>I <b>Fractated</b> a track with a pitch expansion of zero, then selected <b>Stretch/Move</b>, but couldn't do anything with the pitch ratio.</p>	<p>If the track is all on the same note, the pitch <i>range</i> is zero. No matter by what ratio you multiply this, the result will always be zero, therefore nothing at all happens when you try it.</p>
<p>I <b>Fractated</b> a track which played perfectly well, but after I <b>quantized, reflected</b> or <b>rotated</b> it, I got some very bizarre effects like zipping or swooping up and down between different notes.</p>	<p>The instrument on that MIDI channel was probably set to a monophonic patch with “fingered portamento” (most applicable to Yamaha instruments). Whenever that voice receives a note-on before the previous note is taken off, it will zip or swoop to the new note without a fresh attack. This will never happen in your original <b>Fractation</b>, but these editing functions frequently produce polyphonic results. Select a polyphonic voice patch and you should be OK.</p>
<p>I copied the parameters of one track to another, but some of the values (the ones in reverse video) had different values.</p>	<p>This is exactly as it should be, because those parameters in reverse video have been randomised, so when they are copied the copies will acquire new random values.</p>

- ⇒ *If you find any other points which you think should be included here in future editions of the manual, please let us know. We welcome feedback, comments and suggestions from users.*

## APPENDIX F

# GLOSSARY

A list of terms associated with computers, MIDI, mathematics, music, etc., etc., which you may find useful ...

**Alert box**A box that appears on the screen with a short message or question and one or more buttons to click on with the mouse. There is usually (but not always) one of three icons: !, ? or **STOP**. There are numerous illustrations of alert boxes in this manual.

**F**

**ASCII** American Standard Code for Information Interchange. Usually used in connection with text or control characters used and produced by computers. Each character has a number from 0 to 255, *eg* A is 65, 1 is 48, z is 122.



**Auto folder**A special folder, always named “AUTO”. When the ST boots up, it looks on the disk to see if this folder is present. If so, it runs any programs in it. These might have various functions, such as installing a RAM disk or an improved file selector. (see *folder*, *RAM disk*)

**Canon**A common musical form employing imitative counterpoint. That is to say, different parts or voices enter in succession, playing or singing the same melodic material. The various parts may be transposed to different pitches or, in the case of more modern composers such as Nancarrow or Ligeti, be at different speeds. The parts may also be inverted, in retrograde, or otherwise transformed.

**Control change** “catch-all” bit of MIDI data representing any number of different musical parameters, *eg* sustain pedal on/off, the instrument’s volume, portamento on/off, portamento time, breath control, etc., etc.

**Cyclical mathematics**the case of **FRACTAL MUSIC** this has two simultaneous meanings: at the simpler level, it merely means a repetitive process that goes round and round. On a more complex level, each new

value of  $x$ ,  $y$  and  $z$  that is produced depends on the previous values of all three— $x$ ,  $y$  and  $z$ . This is known as a feedback loop (see *iteration*)

**Default** Commonly used in computer-speak, it usually means a value of a variable (which might be a number or a filename, etc.) which is set up in the program. This value can be changed by the user, but if it isn't, the default value is used. It can also apply to one of a choice of buttons in an alert or dialogue box. The default button is always shown with a thicker border than the others, and pressing  or  has the same effect as **Clicking** on this button.

**Desk accessory** small program which is loaded into memory at boot-up time, and can be accessed from the **Desk** menu at any time during the running of other programs. The purposes of these vary widely, but include the *Control Panel*, which allows you to set various system parameters (such as whether or not you get a beep every time you hit a key, colours, key repeat speed, time, date, etc.); programs to let you print out disk directories, take “snapshots” of the screen, alter the mouse response speed, etc., etc. The ST can hold up to 6 accessories in memory at once and the files always have the extension .ACC.

**Desktop** When you switch your ST on, you are said to be in the “desktop” area, *ie* not in any program, and showing a file directory window, disk icons and trash bin. At this point you can set your preferences as to colour, whether the files are shown as text or icons, how they are sorted, the positions of the various icons, windows, etc. By doing a “Save desktop” operation from the menu, this information can be stored so that when you next boot with that disk the screen will look the way you want it. This information is stored in a file called DESKTOP.INF.

**Directory** A list of files and folders on the disk, or in a particular folder, such as you are presented with when you “open” a disk from the desktop or use a file-handling option in a program.

**Folder** A sub-directory containing a number of files on the disk. Using folders makes disks much easier to handle by avoiding colossal single lists of files. Each folder is one entry in the next directory “outwards”. When a folder is opened, only the files (and maybe further folders) in that folder are displayed. (see *directory*)

**F**

**Fractal Geometry** type of geometry that was discovered/invented by the mathematician Benoit Mandelbrot, after whom the “Mandelbrot Set”, the classic image of Fractal Geometry, was named. It is a process that produces an infinite degree of detail, no matter how much enlargement or “zooming in” takes place. There is often a degree of self-similarity, *ie* similar shapes reappear at different scales. Fractals are seen as the geometry of nature, and can produce, in computer graphics, very natural and lifelike forms from single fern leaves to entire landscapes, often from comparatively simple, but very repetitive, mathematics. It is a phenomenon that could only have arisen in the age of the computer. For an introduction to the wider world of “Chaos”, of which fractals are just one aspect, James Gleick’s *Chaos* and Ian Stewart’s *Does God Play Dice* are recommended reading for the layperson.

**F**

**Iteration** A word commonly used in the language of Fractals. Mathematical processes which generate fractals generally involve large numbers (often thousands or even millions) of repetitions of the same mathematical operation, usually in the form of a “feedback loop”. This repetitive process is called iteration. (see *cyclical mathematics*)

**Meta-event** special type of event which provides for the inclusion of non-MIDI information in MIDI Files, including tempi, time signatures, titles, system exclusive data, etc.

**MIDI** This stands for Musical Instrument Digital Interface and is the general term for the technology whereby synthesizers can “talk to” other synthesizers, computers, samplers and a whole range of MIDI devices.

**MIDI channel** This is how MIDI information is separated out between different instruments or other devices. There are 16 MIDI channels as standard, and each device is assigned its own channel so that they don’t conflict with each other. Since the advent of many multi-timbral, multi-channel devices, 16 is no longer enough, so it is now possible to use various devices which provide up to 4 banks of 16 channels.

**MIDI data** This is in the form of numbers (or digits, hence digital) which are produced by every type of MIDI event, whether it is a note on or a move of the pitch-bend lever, a change of voice on the instrument, a press of the sustain pedal, etc. It is this type of data that is generated and edited in this program, then sent to the instrument(s) so that it can be heard.

**MIDI File** A file standard which allows MIDI data to be transferred between different MIDI software programs, sometimes on different computers.

**MIDI Thru** The means whereby MIDI data is “passed on” from one device to another without affecting the intermediate device (MIDI instruments usually have *MIDI In*, *Out* and *Thru* connections on the back). In the case of software, the MIDI data can be modified *en route* by specifying a MIDI channel for the output, transposing, etc.

**F**

**Modulation**(see *pitch bend*) Another wheel or lever (sometimes pitch bend and modulation are combined into one lever which moves in two dimensions—*eg* Roland keyboards). This one alters the sound in whatever way has been programmed on the instrument, but usually increases or decreases the amount and depth of vibrato. This translates into memory-intensive MIDI data.

**Monophonic** One note at a time. A clarinet or a trombone, for example, is a monophonic instrument. The material **Fractated** by this program is monophonic for each track, and sound patches or voices on MIDI instruments can be set up as monophonic. (see *polyphonic*)

**Multi-timbral** This term is applied to MIDI instruments which can produce a number of different sounds simultaneously (typically up to 8, though with the advent of the “General MIDI” standard, 16 is becoming common), and these sounds can be assigned to different MIDI channels.

**Pitch bend** In playing terms, there is usually a lever or wheel somewhere on a synthesizer keyboard which, when moved, alters the pitch of the sound (like “bending” a string on a guitar). This is also translated into MIDI data—and uses a lot of memory.

**Polyphonic** More than one note at once. A piano, harmonica or guitar, for example, is polyphonic. Synthesizer patches can be set up as polyphonic—they usually are, nowadays, except for special solo purposes needing portamento, etc. (see *monophonic*)

**Program change** Also known as “patch change”. The changing from one sound, voice, patch or program to another on a synthesizer. This is also MIDI information.

**RAM disk** An area of the computer’s memory that is set aside for storage—as a “virtual” floppy or hard disk. RAM disks are much faster to use than other kinds of disk—pretty well instant, in fact, and make for very efficient and convenient working. The down side is that the working memory is thus reduced by the size of the RAM disk (*eg* half a megabyte in a one megabyte ST), and that the data stored on a RAM disk is lost when you switch off, and should therefore be transferred to a permanent disk before you do so. Some RAM disks, however, are “reset-proof”—the information is preserved intact when you press the reset button. (see *reset button*)

**F**

**Reset button** The small button on the back of the ST which allows you to re-boot without switching off and on again.

**Resolution** The degree of detail in which information is stored or displayed. Most commonly (in computing) applied to screen resolution: the more “pixels” (picture elements or dots) in either direction, the higher the resolution. On the ST, there are 3 screen resolutions available: high (monochrome only) has 640 x 400 pixels, medium (colour only) has 640 x 200 and low (more colours) has 320 x 200. **FRACTAL MUSIC** runs in high or medium resolution. It is also applied, in MIDI, to time or “tick resolution”, which refers to the number of ticks per beat. (see *tick*).

**Resource file** A file to be found with many programs (including **FRACTAL MUSIC**), without which the program will not run. It always has the extension .RSC, and contains most of the GEM information such as menus, alert boxes, help screens, etc. (see *alert box*)

**Reversed display** “reverse video”. Photographers would call this “negative”. In monochrome, black becomes white and vice versa; in colour it’s more complicated, but colour negative is still a fair analogy.

**Root directory** The first, or “outer”, directory that you see when you double-click a disk icon to open it. Any folders listed in the root directory are therefore sub-directories of the root directory. (see *directory, folder*)

**Sequencer** A program for recording MIDI data—a kind of digital recording. Music is usually entered into a sequencer by playing it on a MIDI keyboard instrument, and can then be (usually quite extensively) edited. The sequencer will play back the music by sending the same MIDI data back to the MIDI instrument(s). **FRACTAL MUSIC** could, in part, be regarded as a playback-only sequencer, though it generates its own music instead of recording the user’s playing. (see *MIDI, MIDI data*)

**F**

**System exclusive** “SysEx”. MIDI data which usually concerns specific voice parameter information, as opposed to the actual playing or music itself. For the more advanced user, who will know what it is anyway.

**Tick**, clock or pulse. The smallest unit into which any given MIDI program divides time. **FRACTAL MUSIC** has a tick resolution (often expressed as *ppqn*: pulses per quarter-note) of 96. (see *resolution*)

**Transformation Geometry** type of geometry whereby one shape is transformed into another shape or moved to a different position by means of a mathematical calculation. Typical examples are rotation, reflection, stretching, shrinking (all used in this program), shearing (moving one end but not the other), as well as more sophisticated circular transformations and those in three or more dimensions.

**Velocity** MIDI-speak for how hard the key was hit on the instrument, the idea being that the harder you hit a note, say, on the piano, not only the louder does it come out, but the faster it goes down. This is easily measurable by electronic devices and “key velocity” has become a generally accepted term. With most sounds, a higher key velocity is interpreted as louder, but it is often possible to program the sound so that velocity has a different effect—the sound might be brighter, or have increased vibrato, etc.

## APPENDIX G

# FUTURE PLANS

These are some ideas for future developments to **FRACTAL MUSIC**, without any promises or implied time scale, and in no particular order ...

- ▷ Facility for mixing and appending tracks.
- ▷ Facility to delete part of a track.
- ▷ Fuller handling of imported MIDI File tracks containing data on more than one channel.
- ▷ Preservation of all tempi and time signatures in a MIDI File (not just the first of each) and, in the case of tempi, incorporation into playback.
- ▷ Regional editing facility—*ie* edit part of a track and leave the rest unaffected.
- ▷ Editable event list and passes screen.
- ▷ General handling of wider range of MIDI data (at present **FRACTAL MUSIC** only generates note on/note off data) ... possibly extending **Fractation** into more than 3 dimensions.
- ▷ Facility to select alternative mathematical processes and/or to give users a degree of control over some of the more central parameters (all very hidden away at present).
- ▷ “Vertical Quantize”—ability to force the music into a key or a user-defined scale.
- ▷ Allowance for using 24-note scale when appropriate MIDI instruments are used (see **Chapter 12**).
- ▷ More types of transformation geometry to be offered for editing, possibly allowing user-defined object-shapes.

**G**

- More flexible and accessible interface for Other reflects/Rotate, allowing the user (for instance) to move the origin *after* setting the angle.
- Import track facility, to load a single track (from .FM2 or .MID) into the current piece.
- Alternatives to the “folding” process when the notes go outside the specified range (*eg* octave transposition, looping to the other end of the range, omitting entirely); to apply to editing, as well as to **Fractating**.
- Editing in three (or more) dimensions.

Finally, we would very much like—time, opportunity and skills allowing—to produce a version of **FRACTAL MUSIC** for the Apple Macintosh.



*... Watch This Space*

---



---

# INDEX

Items shown in **Bold type** are specific and/or important to **FRACTAL MUSIC**.

Page numbers in **this type** represent the principal reference(s) to that item.

Some items are not listed here because they appear frequently throughout the manual—such as keyboard, parameter. In other cases, where an item is common (*eg* Alert box), only the first or most explanatory references are listed.

## A

**Absolute** 66, 68. *See also* Quantize

Aftertouch 108

Alert box **15**, **110**

All parameters (printing) **55**

**Angle** **76–78**

ASCII 39, 84, 101, 103, **110**

Augmentation 25

AUTO folder 13, 53, **110**

**AUTOLOAD file** 11, 13, 19, 30,  
32, 34, 50, 77, **85**, 108

**Axis** **72–73**, 74, 76, 108

## B

Bach, J.S. 29, 71

Backup file 52, 54

Boulez, Pierre 81

## C

Canon 110

**Centring pitch.** *See* Pitch: centring

Channel pressure. *See* Aftertouch

Chaos 112

Cheating 44–45

Check passes. *See* Passes; Passes: check

Clock. *See* Tick

Coffee 55

Colour **14**, 33, 34

Control change 88, **110**

Control Panel 14, 111. *See also* Desk  
accessories

Copying

MIDI data 71, 82

parameters 44, 57, **61**, 109

Curious phenomenon 29

Cursor-box 21, **34–36**, 65

Cyclical mathematics. *See*  
Mathematics: cyclical

## D

**De-randomise** 21, 40, 48, **59–60**,

90. *See also* Randomising

Default **34**, 92–93, **111**

button 4, **16**, **111**

Delete file 17, **54**

Desk

-top 11, **111**.

*See also* Save Desktop

accessories 13, 49, 87, 107, **111**

menu **49**, 64, 111

Dialog box **16**

Directory 53, **111**, 115

- Disaster 53
- Disk  
directory. *See* Directory  
drive(s) 53  
space 52
- Disks  
changing 53
- E**
- Edit menu** 22, 24, 56, 66–68
- Erase MIDI** 60
- Event list** 55, 61–62, 64, 90, 108
- F**
- Feedback loop 43, 111, 112
- File  
menu 27, 28, 30, 50–54, 64  
selector 13, 17, 27, 52, 53
- Folder 13, 108, 111, 115
- Folding** 29, 47–48, 73, 79–80
- “Fractal” button** 31
- Fractal geometry. *See* Geometry:  
fractal
- Fractals 2. *See also* Geometry: fractal
- Fractation** 19–20, 36, 38–40, 58,  
63, 65, 85, 87, 90, 91, 109, 113
- Function keys 18
- G**
- Geometry**  
fractal 2, 43, 112. *See also* Fractals  
transformation 3, 115
- Gleick, James 112
- H**
- Help 64–65
- “How many” parameters**  
41–43, 63–64, 91
- I**
- Inner loop** 43, 63, 90, 91
- Interest rates 44
- Invert** 22, 64, 72–73, 74, 91, 108
- IRCAM 81
- Iteration 43, 112
- K**
- Keyboard Input  
64, 65, 83–84, 99–101
- Kirk, Captain 12
- L**
- Ligeti, György 110
- Limits 92–93. *See also*  
Pitch: limits; Velocity: limits
- Loading 17, 50–51, 65, 87  
all 50  
MIDI File 28, 50–51  
parameters 50
- Local Control 65
- Loops** 38, 41–43, 48, 63, 90, 91.  
*See also* Inner loop
- M**
- Mandelbrot, Benoit 112
- Mathematics**  
cyclical 2, 41–43, 110.  
*See also* Fractals  
3-dimensional 2, 41–43
- Memory 3, 11, 30, 33, 40, 64,  
86–87, 107, 114
- Menu selection 16–17
- Meta-events 103, 105, 112
- Microtones 81, 89–90
- MIDI 46, 112  
channel 19, 33, 36, 41, 62, 65,  
89, 90, 112, 113

data 19, 56, 62, 88, **113**, 115  
  printing 55, 56  
File 28, 50, 51, 53, 58, 88,  
  **103–106**, 108, 112, **113**  
  Thru **65**, **113**  
Modifier keys 3, **18**  
Modulation 88, **113**  
Monophonic  
  20, 58, 64, 82, 109, **113**  
Mouse 4, **15**  
Move. *See* Stretch/Move  
Multi-timbral 33, 89, 112, **113**

## N

### Name

**track** 21, **60**, 83.  
    *See also* Title: track  
  **work** 26, **60**, 83.  
    *See also* Title: work  
Nancarrow, Conlon 110  
Naughtiness 106  
New work. *See* Start new work  
Non-note data 58, **88**, 108  
Note off 48, 88, 104

## O

Oddities. *See* Quirks  
**Origin** 75–76  
**Other menu** 56, 61–65  
**Other reflects** 58, 74–75, 109

## P

**Passes** 63–64, 87  
Pause **39**  
Pedantry 81–82  
**Pitch** 44  
  bend 81, 88, 108, **113**  
  **centring** 29, 78–79  
  **expansion** 47–48, 91, 109

**limits** 46–47, 72–73, 78, 108  
  range 70–71. *See also* Pitch limits  
  **starting** 47, 48  
“**Play**” button 20, 31  
**Play(back)** 20, **39**, 65, 108  
Political significance 4  
Polyphonic  
  20, 29, 58, 82, 109, **114**  
PREL2.MID 11, 13, 28, 71, 87  
**Print menu** 55  
Program change **114**  
**Protect** 22, 40, 56, **59**  
Pulse. *See* Tick

## Q

**Quantize** 29, 58, 66–68, 74, 109  
Quirks 54, **104**  
Quit 54, 64

## R

RAM disk 13, 87, 107, **114**  
**Randomising** 19, **36**, 39, 40, **48**,  
  61, 85, 92, 109  
**Reflection** 72, 73, 115.  
  *See also* Other reflects  
Registration 12  
**Relative** 66–67  
Reset button 107, **114**  
Resolution **114**  
  screen 13, 33, 107  
  tick 66, 104  
Resource file 11, 107, **114**  
Rests 43–45, 106  
**Retro/Invert** 73, 74, 91  
**Retrograde** 73, 74, 91  
Reverse video  
  **18**, 21, 36, 56, 109, **115**  
Root directory **115**  
**Rotate** 29, 58, 74–75, 109, 115

**S**

Save Desktop 13, 107, 111.

*See also* Desktop

Saving 17, 27, **51–54**, 59, 65

**Scaling value** 74

Scunthorpe 12

Selecting tracks. *See* Track: selection

Sequencer 27, 36, 61, 66, 88, **115**

Serial number 13

**Solo** 23

Special characters 84, 100–101

Squash. *See* Stretch/Move

**Start new work** 30, **50**

Starting pitch. *See* Pitch: starting

Starting velocity. *See* Velocity: starting

Stewart, Ian 112

**“Stop” button** 31, **39**

Stretch. *See* Stretch/Move

**Stretch/Move**

24, **69–71**, 90, 91, 109, 115

System exclusive 88, 106, **115**

**T**

**Tempo** 4, 25, **32**, 50, 51, 55, 70,  
103, 106

Thru. *See* MIDI: Thru

**Tick** 4, 64, 66–68, 104, **115**

**Time** 44

**position in** 62, 66, 69

**scale** 70–71

**span** 4, 75

Time signature 50, 103, **105–106**

**Title**

**track** 20–21, 32, 51, 55, 57,  
**60**, 83–84, 99, 103, 105

**work** 26, 32, 51, 55, **60**,  
83–84, 99, 103, 105

**Track**

**menu** 21, 22, 56, **59–60**

numbers 32

selection 21, **56–57**

**turning off** **28**, 35

**turning on** **23**, 35

Tracks on only (printing) **55**

Transformation geometry.

*See* Geometry: transformation

Transposition 69, 73, 91, 113

12-bore 80

24-note scale 89

**U**

Unfractal 91

**Unprotect** 40, 57, **59**

**V**

**Velocity** 42, 44, 58, 115

**expansion** 48

**limits** 48

**starting** 48

**Version** 43–45, 48, 90

**W**

WordStar diamond 71

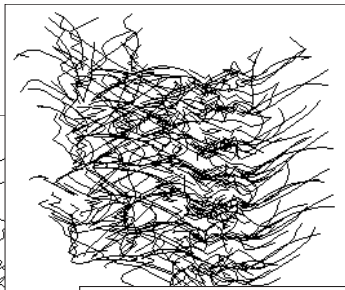
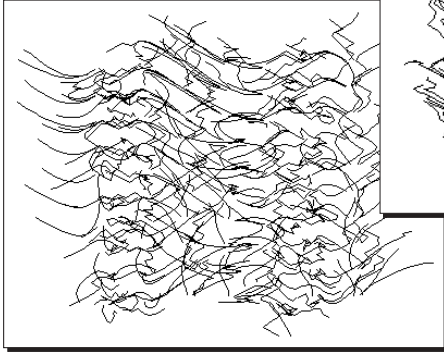

- ↳ The program that generates limitless numbers of different musical phrases—from parameters set (or randomised) by the user—using a Fractal algorithm.
- ↳ The program that manipulates musical material like no other, including stretching or squashing in pitch or time, rotation through any angle and reflection in an angled axis.
- ↳ 16 tracks of MIDI data can be created and/or manipulated.
- ↳ Full two-way MIDI File compatibility: export your Fractal creation to another program for incorporation in a major composition, or transform your music recorded in a sequencer.



*Written by Chris Sansom  
with Laurence Glazier*

